

FRANC2D

*A Two Dimensional Crack
Propagation Simulator*

User's Guide

Version 3.1

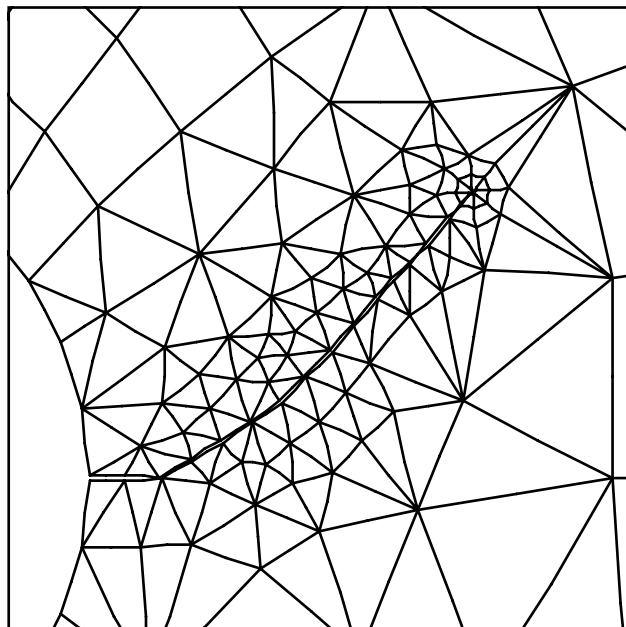

Copyright © 1991, 1992, 1993 Paul Wawrzynek and Anthony Ingraffea
All Rights Reserved

FRANC2D software distribution

The principle means of distributing the FRANC2D program is electronically using anonymous ftp on the internet. This is by far the easiest way to get the most up to date version of the program for a specific workstation type.

An anonymous ftp server has been set up at Cornell University to help distribute the software. To use the server, connect using one of the following commands

```
% ftp ftp.cfg.cornell.edu
```

or via a web browser

```
% ftp:\\ftp.cfg.cornell.edu
```

An example ftp interactive session is shown below.

```
% ftp ftp.cfg.cornell.edu
Connected to ftp.cfg.cornell.edu
220 ftp.cfg.cornell.edu FTP server (Version 4.1 Sat Nov 23
12:52:09 CST 1991) ready.
Name (ftp.cfg.cornell.edu:lambic): anonymous
331 Guest login ok, send ident as password.
Password: wash@stout.cfg.cornell.edu (use your user name and
host here)
230 Guest login ok, access restrictions apply.
Remote system type is UNIX.
ftp> cd pub/software
250 CWD command successful.
ftp> binary
200 type set to I.
```

You are now in the software distribution directory, and should choose the appropriate executable for your machine. Currently these are:

DEC ALPHA	(OSF 4.0D)
SUN	(Solaris 2.6)
HP	(HPUX 11)
LINUX	(RH 9.0)
MSWindows	(NT/2000/XP)

These are compress'ed and tar'ed executable versions of the programs. To retrieve a program use commands similar to the following:

```
ftp> get franc2d.gz
local: franc2d.gz remote: franc2d.gz
200 Port command successful.
150 Opening data connection for SG_6_franc2d.tar.Z (1103567
bytes)
```

```
226 Transfer complete.
1103567 bytes received in 43.48 seconds (24.79 Kbytes/s)
ftp> get casca.gz
local: casca.gz remote: casca.gz
200 Port command successful.
150 Opening data connection for casca.gz (645613 bytes)
226 Transfer complete.
645613 bytes received in 43.73 seconds (14.42 Kbytes/s)
ftp> quit
221 Goodbye.
```

```
% gunzip franc2d.gz (uncompress the files)
% gunzip casca.gz
% chmod a+x franc (extracted file name is made executable)
% chmod a+x casca
```

The FRANC2D program is still actively under development, and versions on the server are updated from time to time. At any given time, the server may contain different versions for different workstation types. Version 3.1 is available for some workstations.

Source code for FRANC2D can be made available by special arrangement. However, due to the dynamic nature of the code, no attempt is made to keep updated versions of the source available on the ftp server. In addition, one should be aware that there is about 6Mbytes of source code. Such a large program does not lend itself to casual perusal and modification. To arrange to have a snapshot of the source code made available, send a request to wash@stout.cfg.cornell.edu.

Contents

INTRODUCTION	1
FRANC2D Files.....	3
FRANC2D Tutorial Example Problem.....	6
Building an initial mesh with CASCA	7
Setting an appropriate data space.....	7
Creating the problem outline	7
Adding Subregions and Subdivisions	9
Mesh Generation.....	10
Performing a FRANC2D Simulation.....	11
Setting the analysis type and material properties	11
Boundary Conditions	12
Stress analysis and postprocessing	15
Crack Location.....	16
Stress analysis and fracture analysis.....	17
Crack Propagation.....	17
Fatigue Crack Growth analysis.....	19
FRANC2D Menu Reference Guide	20
THE MAIN PAGE.....	20
PRE-PROCESS.....	21
MODIFY.....	21
ELEM STIFF	21
ANALYSIS.....	21
BOUNDARY	21
POST-PROCESS	22
ANNOTATE.....	22
NODE INfOrMation.....	22
READ FILE	22
WRITE FILE	22
BIG WINDOW	22
RESET	23
- ZOOM +	23
PAN.....	23
SNAP	23
HELP.....	23
END	23
PREPROCESSING FUNCTIONS	24
FIXITY	24
INTeRFaCE FIXity.....	25
LOADS	25
-CASE+.....	25
DELETE CASE	25
POINT LOADS	25

DIST LOAD.....	26
BODY LOAD.....	26
IN-SITU LOAD.....	26
THERMAL LOAD.....	26
RESIDUAL LOAD.....	27
INTERFACE LOAD.....	27
APPLIED DISPLACEMENT.....	28
EDGE CRACK PRESSURE.....	28
INTERNAL CRACK PRESSURE.....	28
X BOTH Y.....	28
MATERIAL.....	28
CRACK DEF.....	31
SINGULARITY.....	31
USER DEFINED.....	31
INTERFACE TOUGHNESS.....	31
PROBLEM TYPE.....	31
MODIFICATION FUNCTIONS.....	32
ADD Q8, ADD T6, KILL ELEM, DRAG NODE.....	32
NEW CRACK, MOVE CRACK.....	34
SHOW ANGLE.....	36
INTERFACE OFF/ON.....	37
ADD INTERFACE.....	37
ADD NonLinear INTERFACE.....	37
MORE OPTIONS.....	37
SUBDIVIDE.....	37
T6 TO CQ8, CQ8 TO T6.....	38
ADD GAP ELEMENTS.....	38
ADD BIMATERIAL GAP.....	38
POSTPROCESSING FUNCTIONS.....	39
-CASE+.....	39
FRACTURE MECHANICS.....	39
LINE-PLOT.....	39
CIRCLE-PLOT.....	40
RADIAL-PLOT.....	40
NODAL INTERNAL FORCE.....	40
STRESS-BAR.....	41
CONTOUR.....	41
DEFORMED MESH.....	42
NODE-INFORMATION.....	42
MULTIPLE NODE-INFORMATION.....	43
RESIDUAL STRESS/STRAIN FILE.....	43
RETURN.....	43
FRACTURE MECHANICS FUNCTIONS.....	44
-CASE+.....	44
DISPLACEMENT CORRELATION SIF.....	44
INTERACTION.....	44
SIF HISTORY.....	45
FATIGUE PLOTS.....	45

J INTEGRAL	45
MoDified CRaCK CLOSure	45
MORE OPTIONS	45
RETURN	45
CASCA Menu Reference	46
MAIN Page	46
Set Scale Page	47
Geometry Page	48
SubRegion Page	50
Subdivide Page	50
Mesh Page	51
Appendix A – The .inp file format	53
Appendix B – The .tdi file format	56
Index	57

INTRODUCTION

FRANC2D is a highly interactive program, and, despite all of its capabilities, it is surprisingly easy to learn how to use all of its features. This manual provides a reference for the use of program. The first section describes the files and file naming conventions used by the program. The second section is a tutorial illustrative example. (Most of the commonly used features of the program are introduced in the tutorial.) The third section is a menu reference, which describes each option on all of the FRANC2D menus. The final section is a reference for the menu options in the CASCA program. CASCA is a program, distributed with FRANC2D, which can be used to generate initial meshes. (An initial mesh is required before a FRANC2D simulation can be performed.)

In this manual, words with all letters upper-case and bold, such as **FIXITY**, refer to options on a FRANC2D or a CASCA menu. Words with all letters in lower-case, italics, and bold, such as *message window*, refer to a screen window or other specific screen area in which the function being discussed is controlled.

Within the FRANC2D program, all user commands are made by clicking the mouse on one of the options displayed on the menu which always appears to the right of the *operations window*, Figure I-1. The commands are arranged in a tree, and the user travels up or down to each branch recursively by selecting the desired option with the left button of the mouse. A *message window* is always present below the operations window to prompt the user on the next step in the requested procedure. For some operations FRANC2D creates a separate detached movable window called the *auxiliary window*. At times it may be necessary to move this window in order to view information in a number of windows simultaneously. Entry into FRANC2D, some data entry, and I/O operations invoked during the running of FRANC2D are made from the *program control window*. This is the window (usually an XTerm) from which the program was started.

The FRANC2D program uses two types of cursors. The normal cursor has the shape of an arrow. When you see this cursor it means that the program is waiting for you to select a menu option or some other graphical input. The second cursor is a stylized wristwatch. When you see this cursor it means that either the program is processing data (e.g., performing a stress analysis), or it is waiting for input in the *program control window*.

The coordinate system used within the programs are always fixed so that the x and u coordinates are horizontal, increasing to the right. The y and v coordinates are vertical, increasing going up. For axisymmetric problems, the horizontal direction corresponds to the radial (r) coordinate, and the axial (z) coordinate is vertical. The axis of rotation is always about $r = 0$.

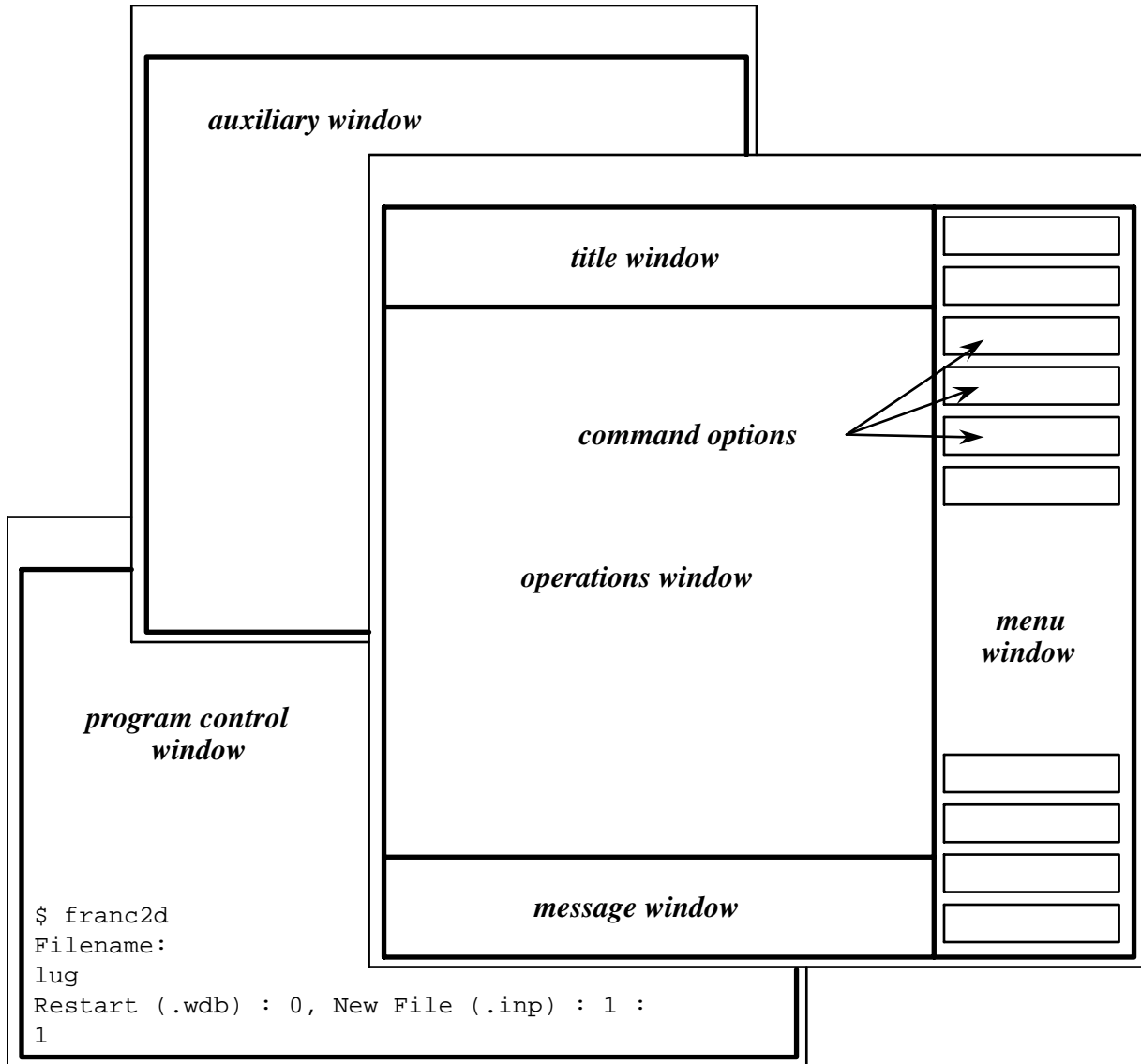

Figure I-1. The FRANC2D windows.

FRANC2D Files

There are a number of different types of files generated or used by the FRANC2D program. The contents of these files and their uses are discussed here. A schematic of the files and information flow is shown in Figure F-1. In most cases, the *'s in the figure are replaced by file names chosen by the analyst. Exceptions to this rule are discussed below.

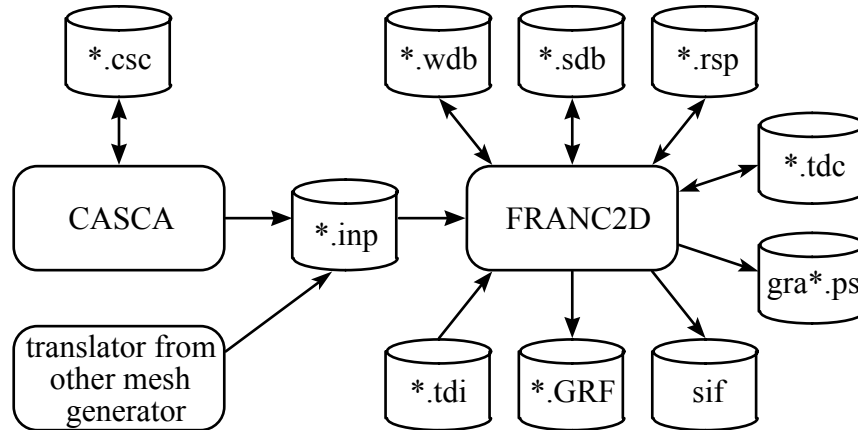

Figure F-1. Information flow and files associated with FRANC2D.

Input and Casca Files

*.csc files

The CASCA program is a simple mesh generating program. Although strictly speaking, it is not part of FRANC2D, it is distributed with FRANC2D, and can be used to generate initial meshes for FRANC2D simulations. The *.csc files are restart files generated by CASCA. A restart file allows one to save their current work and recover it later. This is convenient when a mesh description cannot be completed at one sitting, to make modifications to an existing mesh, or to recover one's work if the program crashes. A *.csc file is created when the **WRITE** option (not **WRITE MESH**) is selected in CASCA.

*.inp files

The *.inp files are the means by which new problems are specified for a FRANC2D simulation. These are human readable ASCII files that describe an initial mesh in a format similar to those used by most other FEM programs. The format of these files is specified in Appendix A. The *.inp files can be written by the CASCA program directly (by using the **WRITE MESH** option). If another mesh generation program is used, a translation step is necessary to create the *.inp file. Translators are provided for PATRAN neutral files and COSMOS *.GRF files.

*.tdi files

The *.tdi files allow one to specify an external temperature distribution. These are used to compute initial strains due to thermal expansion. The format of these files is specified in Appendix B.

FRANC Restart Files

The FRANC2D program generates four types of restart files *.wdb, *.sdb, *.rsp and *.tdc files. Restart files allow one to save their current work and recover it later. This is convenient when a simulation cannot be completed at one sitting, to review the results of previous simulations, or to recover one's work if the program crashes. It is recommended that FRANC2D analysts get in the habit of making restart files frequently. Some of the older program messages and documentation refer to "checkpoint" files. This is just another name for restart files. The FRANC2D restart files are generated by the **WRITE** option within FRANC2D.

*.wdb files

The *.wdb files contain most of the information associated with a simulation. This includes the mesh, boundary conditions, cracks, and stress-intensity factors. WDB stands for Winged-Edge Database, the data structure used to store mesh topology and organize most of the other information stored by the program. Unlike the *.sdb and *.rsp files, information in the *.wdb file cannot be recovered if the file is deleted. The *.wdb files are unformatted and are not human readable.

*.sdb files

The *.sdb files contain the individual finite element stiffness matrices. SDB stands for Stiffness DataBase. These matrices are stored in a file to avoid recomputing them each analysis step, reducing computational time considerably. The *.sdb files can become fairly large. Fortunately, they can be regenerated, so it is safe to delete these files to save space. To regenerate a *.sdb file, select the **ELEM STIFF** option and then create a new restart file with the **WRITE** option. *.sdb files are unformatted files, and are not human readable.

*.rsp files

The *.rsp (ReSPonse) files contain analysis results, specifically, nodal displacements. This information is stored in a file so the analysis results can be viewed without reperforming an analysis. The information in these files can be regenerated by performing a stress analysis. The files can be deleted to save space.

*.tdc files

The *.tdc files are used to store an external thermal distribution in a compiled format (Thermal Distribution Compiled). These are ASCII files and are human readable. The information in these files cannot be recovered if the files are deleted.

FRANC2D output files

*.GRF files

The *.GRF files are created when the **FILE** option is selected on the line plot page menu (See the **LINE PLOT** option). These ASCII format files contain the data points used to create the plot displayed in the *auxiliary window*. The first line in the file gives the number of X-Y pairs, and is followed by lines containing an X-Y data pair.

gra*.ps

The gra*.ps files are postscript hardcopy files. These files are created by selecting the **SNAP** option on any menu. The files contain a hardcopy image, in postscript format, of the contents of the data window. The file names are generated sequentially and automatically by the program. A typical series is gra0.ps, gra1.ps, gra2.ps . . . The file number is incremented each time the data window is **SNAP**'d. **WARNING: The file name sequence starts with gra0.ps each time the program is run and new files will overwrite old files. A hardcopy needs to be renamed if it is to be saved.**

sif files

Sif files contain Stress-Intensity Factor histories. A file name extension is not generated automatically for these files. The files contain stress-intensity factors for all cracks for all crack lengths that have been analyzed, in a formatted human readable form.

FRANC2D Tutorial Example Problem

In this portion of the manual, the use of the FRANC2D program is illustrated by way of a tutorial example problem. The steps necessary to build a model and perform a crack propagation analysis are described below. It is intended that you follow along and perform the steps on a workstation as they are described.

The example problem is growth of a through crack from the pin hole in a titanium lug. A schematic of the lug is shown below.

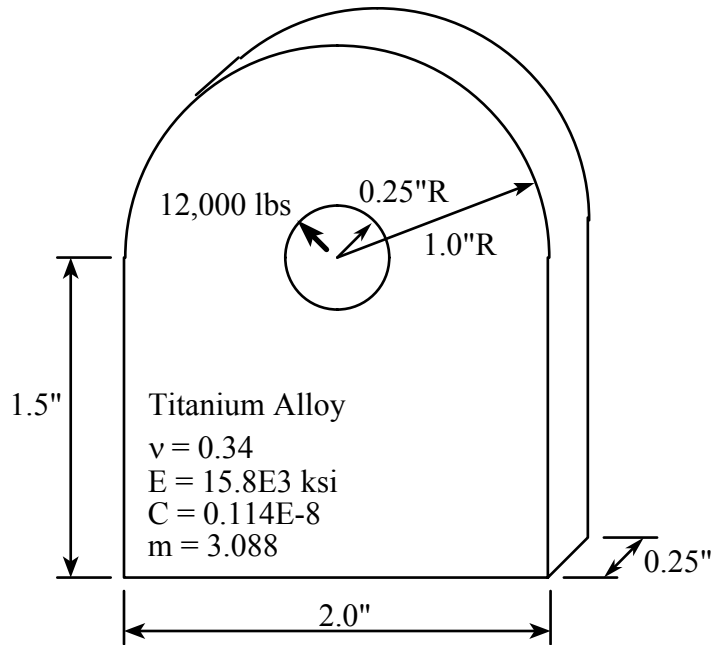

The analysis of the lug is described in two sections. The first section describes the procedures used to build an initial mesh of the lug using the CASCA program. The CASCA program is distributed with FRANC2D. Models can be created with any other mesh generating program, provided a translator is available to convert the mesh description to the FRANC2D *.inp format.

The second section describes the steps necessary for the FRANC2D program to assign boundary conditions, perform stress analysis, to introduce cracks, and to propagate cracks. There are a large number of options and features available in FRANC2D. Only a subset of these are described in this example problem. However, the example has been chosen to illustrate the most frequently used options, and to give you the confidence to try the other features, which are described in the menu reference section.

In the tutorial, menu options are indicated by bold text, such as **Data Size**. Text that you enter in the program control window are indicated with a typewriter font, such as `lug.inp`. On UNIX systems, the programs are run by typing the program name with the appropriate path. The location of the program will vary from sight to sight, but the commands to run the programs will look something like:

```
% programs/franc
% programs/casca
```

As mentioned above, the coordinate system used within the programs are always fixed so that the x and u coordinates are horizontal, increasing to the right. The y and u coordinates are vertical, increasing going up. For axisymmetric problems, the horizontal direction corresponds to the radial (r) coordinate, and the axial (z) coordinate is vertical. The axis of rotation is always about $r = 0$.

Building an initial mesh with CASCA

Setting an appropriate data space

Begin by running the CASCA program. Initially you will have three types of options: setting the data space (**Set Scale**), reading a restart file (**Read**), and adjusting your view (**RESET**, **MAGNIFY**, **ZOOM**, **PAN**, and **SNAP**). Because we are starting a new problem from scratch, we will select **Set Scale**.

At this point we want to adjust the data space and the grid to conform to our current problem. By default, the data window is 12 units wide by 12 units high with a grid spacing of one unit. For the lug problem, if we choose the center of the pin hole to be the origin of our data space, the lug extends 1.5 inches below this point. A nice round number would be to set the data space to 4 units (± 2 units). To do this select the **Data Size** option, and enter 4 on the keypad (ENT stands for enter).

One can use the grid to speed the entry of geometrical data. When the grid is turned on, the intersection points on the grid have “gravity”, and mouse clicks near these points will “snap” to the grid intersection. In the lug problem, it is convenient to set the grid spacing to 0.25. This is done by selecting the **Spacing XY** option and entering 0.25.

If you select **RETURN**, the grid disappears, and a couple of new options are available. One is **Grid**, which redisplay the grid, and turns on the snap-to gravity. You should go ahead and select **Grid**. You should also notice a **Geometry** option. This allows you to specify the outline of your problem, which is the geometry used when generating a mesh. Go ahead and select **Geometry**.

Creating the problem outline

You are now presented with a number of options that you can use to specify the outline of your object. For the lug problem, we will begin with the pin hole. First select **Get Circle**. An arc of a circle is specified by three points. A starting point, an ending point (in clockwise direction) and the circle center. Because of the grid gravity, we can specify the three points by pointing to the screen. First point to the grid intersection just to the left of the center, then to the intersection to the right of the center, and finally to the center. You should see semi-circle that defines the upper half of the pin hole. To accept this curve, you must select **DONE** from the menu. If you select **QUIT**, the arc will be ignored. The lower half of the arc can be defined by

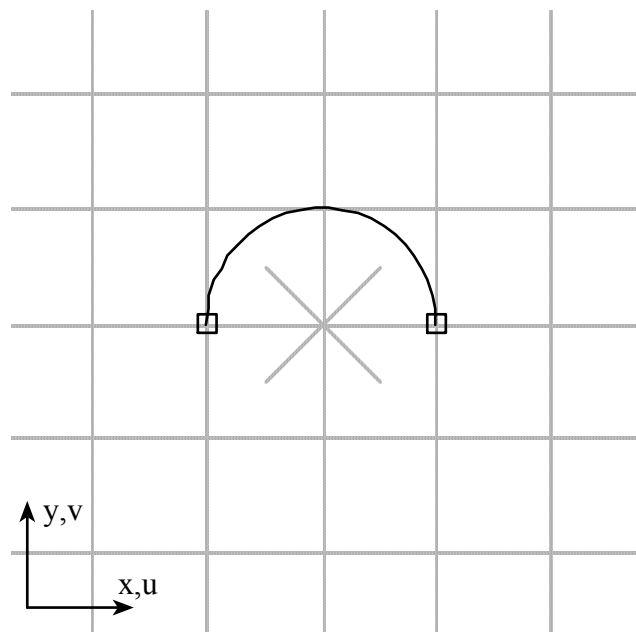

starting on the right, going to the left, and finally selecting the center point.

In a similar fashion, the top arc of the lug can be defined. In this case, the starting and ending points of the arc are four grid spacings away from the center. The data window should now look like this.

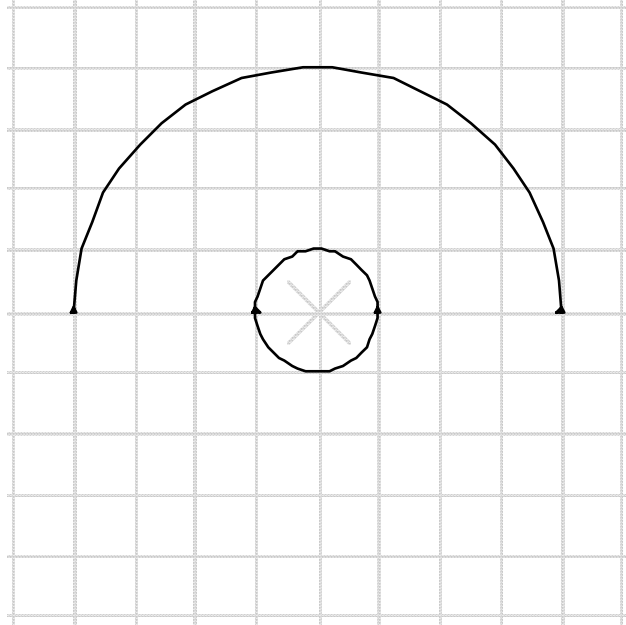

The remainder of the outline can be specified with the **Lines Connect** option. Select this option and point to the left most point of the top arc. This will be the first point of a line segment. Now move down 6 grid intersections (1.5 units) and click again. Now to the right 8 grid intersections, click, and then up to the right most point on the top arc, and click again. To leave this mode of adding line segments, select **QUIT**.

You have now completed the outline of your structure. However, one more step is necessary before you leave this page. You must tell the program that the pin hole is an actual hole, and it should not expect a mesh in this region. To do this, select **Specify Hole**, and point and click inside the pin hole region. You should then select **RETURN** to return to the main page. The model should now look like this.

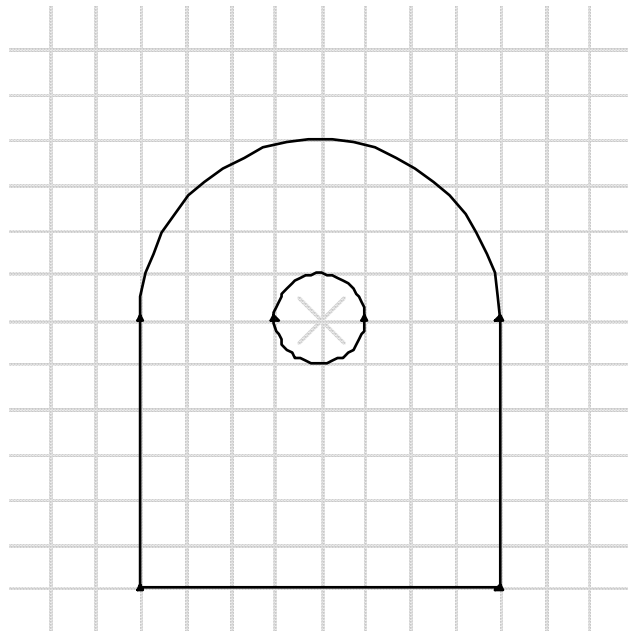

Adding Subregions and Subdivisions

You should now notice that a number of additional options are available on the main page. The next one we will use is **Subregions**. This allows you to break your object up into a number of simpler regions that are more convenient for meshing. If you select this option you will see a number of options that are similar to those available on the geometry page.

In the lug problem, we want to divide the lug into three separate regions for meshing. We do this by adding lines to the model. First we will make the portion of the model above the centerline of the pin hole one region. Select the **Get Line** option, and specify a line from leftmost edge of the lug to the leftmost point on the pin hole. Select **DONE** (not **QUIT**) to accept this line. Repeat the same procedure on the right side of the pin hole. You now have divided the lug into two regions.

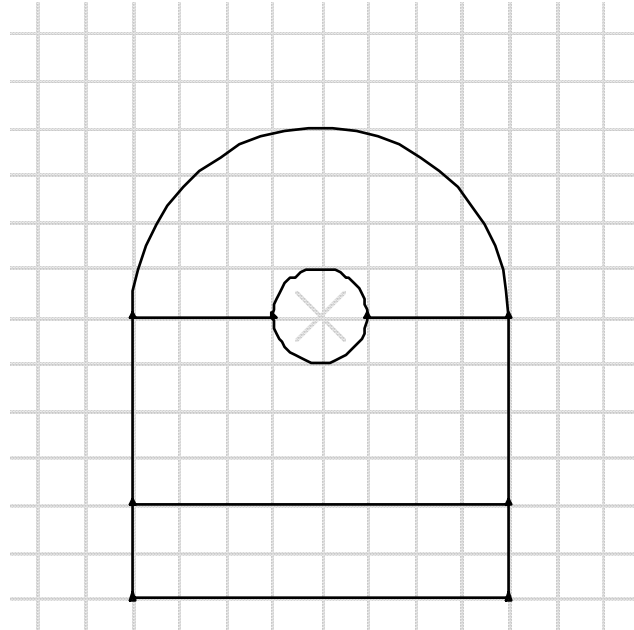

We will do the same thing below the pin hole. Select **Get Line**, and create a line from the location -1, -1, to 1, -1. The problem should now look like this. This is all the division that is necessary, you should now **RETURN** to the main menu and select **Subdivide**.

In the subdivision page, one specifies nodal densities along the boundaries for all the regions in the structure. The arrows along all the edges indicate their orientation, and are used when grading the nodal spacings along the edges.

We will start with the quadrilateral region at the base of the lug. We will use a regular mesh in this region with elements that are 0.25 square. This means the region will be 8 elements wide by 2 elements high.

Select the **No. of Segments** option, and enter 8. Now select the **Subdivide** option to get into a graphical input mode. You should now point and click on the edges that are the top and bottom of this region. You should see triangles to indicate the nodal densities. The **QUIT** option allows you to leave this mode. Now select **No. of Segments** and enter 2. Then specify the nodal density for the right and left sides of this region (remember that you must select **Subdivide** to get into a graphical input mode). The Data window should now look like the illustration on the left.

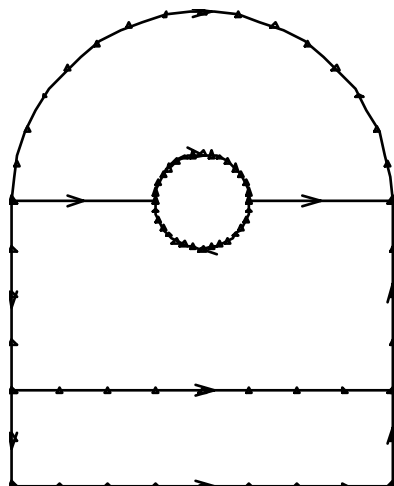

You can now specify the nodal density for the remaining edges that will have a uniform nodal spacing: sixteen nodes along the top and bottom arcs of the pin hole, sixteen nodes along the top arc of the lug, and four nodes on the remaining portions of the right and left sides of the lug. The lug should now look like the illustration shown to the left.

A graded nodal density will be specified for the two remaining

horizontal lines. First set the number of subdivisions to 8, and select the **Ratio** option. You now need to specify two number. In this case we will use 1 and 3. This means that the elements on the far end of the line will be 3 times bigger than those on the near end. Select **Subdivision** to get into graphical input mode. Look at the edge to the left of the pin hole and notice the direction of the arrow. If it points from the pinhole towards the edge of the lug, point and click on the line. If the arrow points toward the pin hole, then select the **Revert Ratio** option, and then point to the line. Repeat this process for the edge to the right of the pin hole. The lug should now look like the illustration shown to the right. You should now return to the main page.

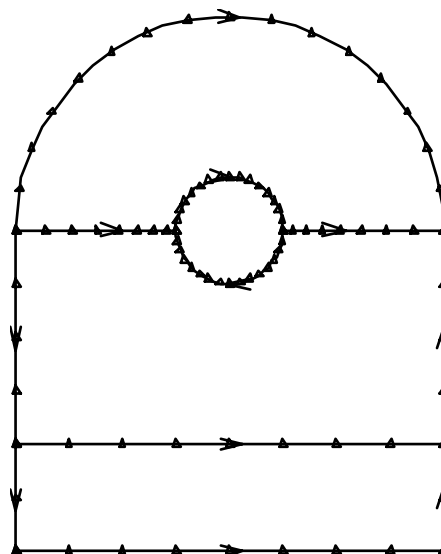

Mesh Generation

The next step is to generate meshes for the three regions. Select the **Mesh** option to move to the mesh page. The first two options on this page allow you to select element types. The defaults are Q8 quadrilateral elements, and T6 triangular elements. **You must use these second order elements with FRANC2D.**

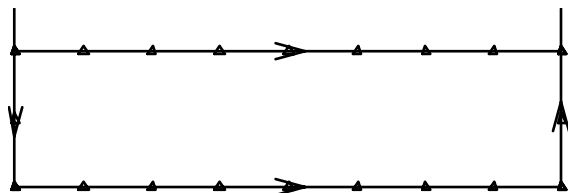

All three regions of the lug can be meshed with the bilinear four sided meshing algorithm (**Bilinear 4side**). This algorithm requires a rectangular region with equal numbers of nodes on opposing sides. It should be obvious that the top and bottom regions satisfy this requirement. We will see how the algorithm can be used for the middle region below.

First we will mesh the bottom region. Select the **Bilinear 4side** option and point and click in the bottom region. A mesh will be generated in this region. Repeat the same process for the top region. The problem now looks like this.

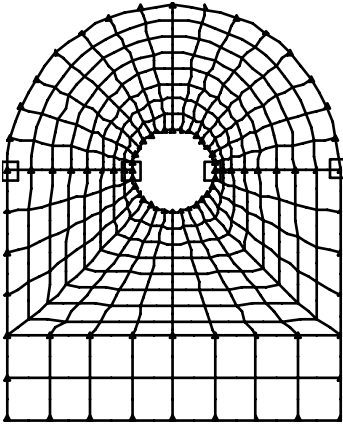

The middle region actually has six sides. However, if we think of the bottom and left and right sides together as one logical side, we have a four sided region with equal nodes on opposing sides. We mesh this by selecting the **Bilinear 4side** option and clicking in the region. The program is not able to determine the four corners of the region, so it prompts you to specify these points. You should point and click on each of the four points that will be the “corners” for the region. These are the points at $(-1,0)$, $(-0.25,0)$, $(0.25,0)$, and $(1,0)$. The program will generate a mesh that looks like this.

Meshing is now complete, you should **RETURN** to the main page. A *.inp file can be created for FRANC2D by selecting the **Write Mesh** option. You will need to specify the file name (call it lug) without the .inp extension on the XTerm terminal window. You may need to move the CASCA window to see the prompt in the terminal window. You may also wish to create a CASCA restart file by means of the **Write** option. You should now **Exit** the program.

Performing a FRANC2D Simulation

Setting the analysis type and material properties

You should now run the FRANC2D program. The program will ask for a filename. Enter lug, with no extension. The program will then ask for a file type. Enter 1, which indicates that we want to read the lug.inp file created in CASCA. The program will then ask if you want to create a Checkpoint (restart) file. You can answer yes, and name the file lug. It will have the extension *.wdb. Next time you run the program you can enter 0 when the program asks for the file type. It is faster to read *.wdb files than *.inp files; the *.wdb files will contain any changes you make to the problem.

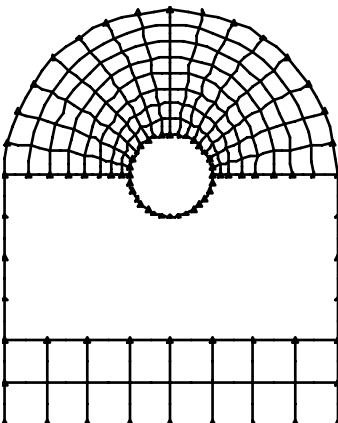

First we will set the problem type and the appropriate material properties. Select **PRE-PROCESS** and then **PROBLEM TYPE**. We see that the current analysis type is Plane Stress, the default. This is what we would like to use, so we can **RETURN**. One can use this page to set the problem type to Plane Strain or Axisymmetry.

Now select the **MATERIAL** option. A new window will appear, and it may be necessary to rearrange the window to see the menu. The new window contains the material properties. The default properties are for steel. We must change this because our lug is made of a titanium alloy. Select **E**, and enter

the Young's modulus of 15.8E3 ksi (the **EEX** key adds the E). Select **Nu**, and enter the Poisson ratio of .34. Set the thickness to 0.25. The K_{Ic} is not necessary for a fatigue analysis so you can leave that as 1.0. Within FRANC2D, K_{Ic} is used for quasi-static analysis, and need not be set otherwise. Density is only used when there is loading due to accelerations (radial accelerations or self weight). Neither of those are present in this analysis, so density can be left at 1.0 also.

You should now **RETURN** from the materials page, and **RETURN** once again to the main page. Because the material properties were modified, you need to reformulate all the element stiffness matrices. This can be done by selecting the **ELEM STIFF** option. Once this is done, it is wise to make a restart file. Select the **WRITE FILE** option and locate the XTerm terminal window (you may need to move some windows to see it, and click in it to make it accept input from the keyboard). You should use `lug` for the file name again. The new restart file will overwrite the old one.

Boundary Conditions

The next step is to specify boundary conditions. First we will add kinematic constraints or fixities. Select **PRE-PROCESS** and **FIXITY** to move to the fixity page. Nodes can be fixed either individually, or along an edge. Each node can be fixed in the X direction, the Y, or both. The fixities work like pushbutton on/off switches; if a fixity is attached to a node, it can be turned off by reapplying the same type of fixity.

The lug will be fixed by applying X and Y constraints along the bottom. Select the **FIX EDGE XY** option. The procedure for adding a boundary condition to an edge is a three step process: you 1) specify a starting node, 2) specify the adjacent node in the direction toward the ending point, and 3) specify the ending node. For the lug, point to the lower left corner of the lug and click. You will see a square. This is the tolerance box. The program assumes that you are trying to select the node within this box. If there is more than one node within the box, the program will pick one, which may or may not be the one you had in mind. Therefore, you should try to ensure that there is only ever one node within the box. This can be done by changing the size of the box. The prompt window (below the data window) can be used to adjust the size of the tolerance box. If you click in this window toward the right, the tolerance box gets bigger; to the left it gets smaller. The closer you are to the left and right edges, the faster the tolerance box will change size. **WARNING: The whole box is active, even if the - <--- Tolerance ---> + message is only in the left portion of the box.**

You should now select an adjacent node. Remember that these are eight-noded elements, so the next nearest node is a mid-side node. You will want to click at the middle of the element edge just to the right of the left corner. This is shown in the figure to the right.

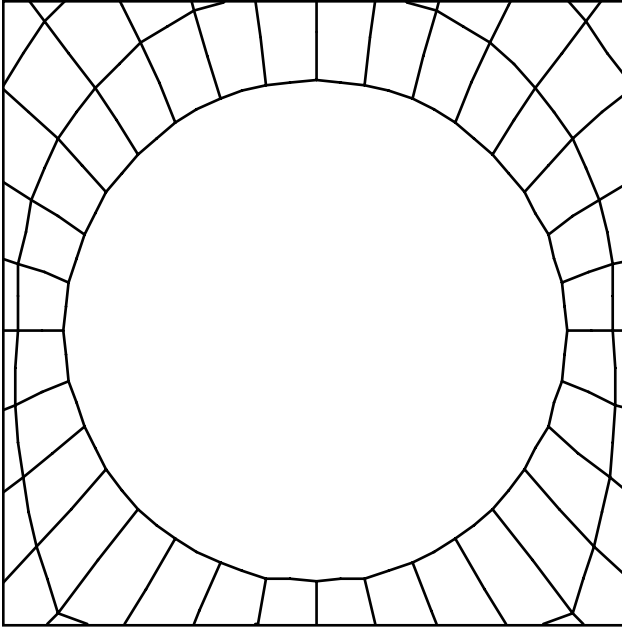

Finally, you should point and click at the lower right node to indicate where the constraints should stop. The display will show a series of X,Y's to indicate that all the nodes along the bottom of the lug are fixed in both the X and Y directions.

You can **RETURN** from this page, and enter the loads page. In a real lug, loading is due to a pin. The bearing of the pin on the lug is a relatively complicated process. For present analysis we will ignore this, and model the pin as a distributed load over a portion of the surface of the hole. You should select the **DIST. LOAD** option. There are four choices for specifying the direction of the load: 1) normal to the surface, 2) tangent

to the surface, 3) in the global X direction, and 4) in the global Y direction. Select the **NORMAL** option because we want the pressure due to the pin to act normal to the surface of the pin hole.

You now have three options for the form of the load distribution: constant, linear, or quadratic. Within FRANC2D, pin loading can best be modeled by a quadratic load distribution over one half of the pin hole. Select the **QUADRATIC** option. We must now specify the portion of the boundary to load just as with the fixity. It will be much simpler to do this if you use the **ZOOM** and **PAN** features to get a much closer view of the hole. (See the descriptions of the **ZOOM** and **PAN** options in the menu reference section.) You should try to get a view such as this.

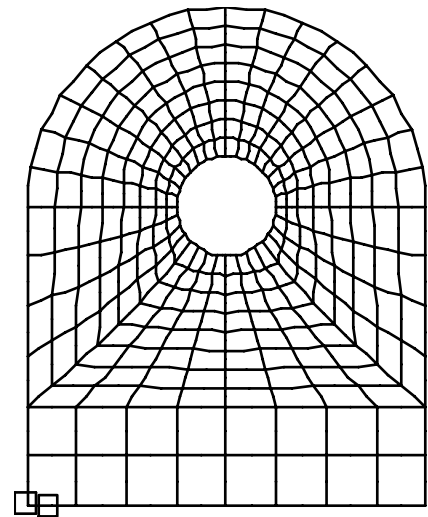

Load specification uses a tolerance box, just as with the fixity. Again, you will want to try to make sure that there is only one node in the tolerance box. A little trick to see the size of the current tolerance box is to click someplace where you know there is no node, such as in the middle of the pinhole, as shown below. This may show you that the tolerance box is much too large. You can adjust it by clicking on the left side of the adjustment window, and then clicking in the middle of the hole again. Once you have the tolerance box the right size, you are ready to specify the first node for the load distribution.

When applying a load normal to the surface, the direction in which you move from start to finish is significant. The rule is, if you are standing at the starting point and looking along the edge toward the stopping point, a positive normal force will act towards your right. For the present model, this means that we want to move from start to finish in a counter-clockwise manner.

The pin load acts at a 45° angle towards the northwest. To distribute this over one half of the pin hole, you will want to start at 45° towards the northeast, and end at 45° towards the southwest. There are 32 elements around the pin hole, so a 45° angle is four elements. If you find the top node, and count four elements to the right, this is the starting node. Click here, and click at the middle of the element side just to the right. Find the ending node by locating the leftmost node on the hole, and count down four elements and click. The screen should look like the illustration shown on the next page.

You must now specify the magnitude of the load at three points along the surface. First enter the load at the starting point; this should be zero. Next the load at the end point, which is also zero. You now need to locate the position of the third point. Usually you want to specify the load at the point midway between the beginning and ending points.

To do this, enter 0.5. You must now enter the magnitude of the load at the middle point. It may take a little computation to determine this number.

The present situation of a quadratically varying load over a circle is among the most complicated configurations that you are likely to encounter. The load will be applied to one half of the total hole. The radial load as a function of angle can be expressed as

$$f_r(\theta) = 4f_{\max} \left[\frac{\theta}{\pi} - \left(\frac{\theta}{\pi} \right)^2 \right], \quad \text{where } 0 \leq \theta \leq \pi.$$

We are trying to find f_{\max} . The radial force has components in both the x and y directions. We are interested in the component of the radial force in the y direction only, because the x

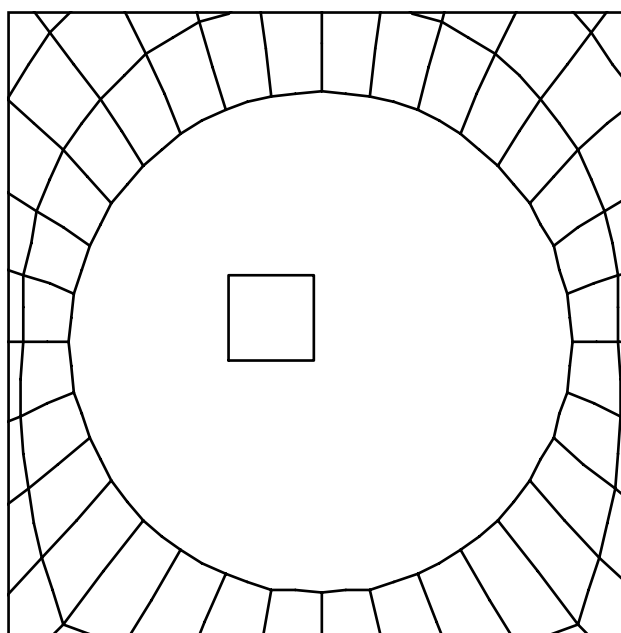
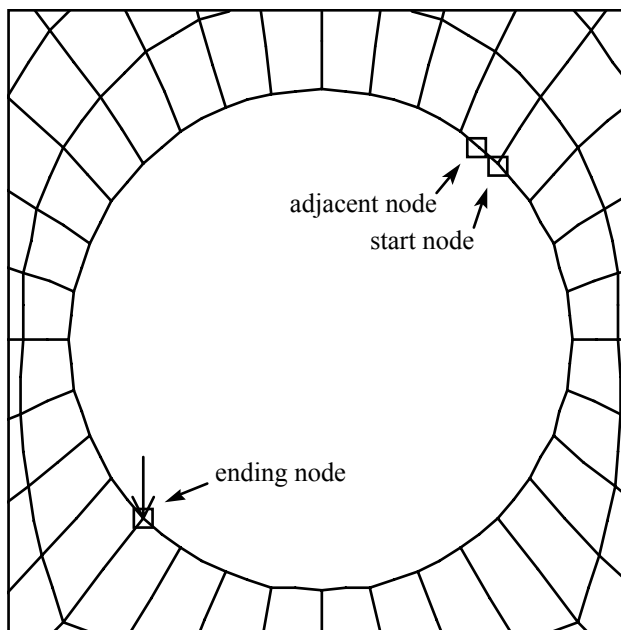

components will cancel. The expression for this is $f_y = f_r \sin \theta$. We must integrate to find the total force applied to the hole. The expression for this is

$$p = 4rtf_{\max} \int_0^{\pi} \left[\frac{\theta}{\pi} - \left(\frac{\theta}{\pi} \right)^2 \right] \sin \theta d\theta.$$

In this expression, r is the radius of the hole, and t is the thickness of the plate. After integrating and solving for f_{\max} , we arrive at the following expression

$$f_{\max} = \frac{p\pi^2}{16rt}.$$

For the lug problem: $p = 12$ kips, $r = 0.25''$, and $t = 0.25''$. Therefore, f_{\max} is equal to 118.4 kips. You should enter this value. We will check this later numerically.

You should now see work-equivalent nodal loads applied to the pin hole. There is an option **X BOTH Y**. If you click on the left side of this button you will see the X loads only, the right side displays Y loads only, and the middle of the button displays both.

We have now specified the boundary conditions. You can **RETURN** from the load page and the pre-processing page to get back to the main page. This is a good time to save a restart file by using the **WRITE FILE** option.

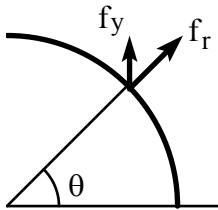

Stress analysis and postprocessing

We are now ready to do stress analysis. Select the **ANALYSIS** option, the **LINEAR** option, and the **DIRECT STIFF** option. The program will now perform a linear elastic stress analysis using a direct elimination (Gauss elimination) solver. This will take a few seconds and the steps are displayed in the terminal window. The steps are:

Reduce Bandwidth: automatic nodal renumbering to reduce the bandwidth of the global stiffness matrix.

Zero Gstf: zero the space used for the global stiffness matrix.

Assemble: assemble the element stiffness matrices into the global stiffness matrix.

Decomposition: perform direct elimination of the global stiffness matrix.

Backsubstitution: perform backsubstitution to recover nodal displacements.

When the analysis has been completed the program will print a little report that summarizes the size of the model and the time required for the analysis.

You can now **RETURN** to the main page and select the **POST-PROCESS** option to enter the postprocessing page. It might be good to select the **RESET** option if you have not already done this.

The first thing to look at is the deformed mesh. This is a quick check to see that the boundary conditions have been applied properly. For the lug problem, the deformed mesh should look like this. Notice that the lug is fixed along the bottom, and the pin loading is acting at 45° .

You can **RETURN** from this page, and select the **CONTOUR** option. This allows you to display color stress contours. You can view individual components of the stress tensor, as well as principal stresses. Of particular interest are the principal tensile stresses (**SIG 1**), because they can be used to indicate potential areas for cracking.

If you **RETURN** from the contour page, we can check the applied load with the **LINE PLOT** option. With this feature you can specify a line anywhere on the object, and plot the stresses along this line. For the present analysis, you should specify a line all the way across the lug near the bottom, and select **SIGYY**, the vertical stress. The distribution of stress along this line will be shown in the auxiliary window. The **INTEGRATE** option sums to find the area under this curve. This is displayed in the terminal window. If the total applied load is 12 kips, we divide this by the thickness to get the load per unit thickness, or 48 kips. Now, the load acts at an angle, so we multiply by the sin of 45° , or 0.7071. The computed area should then be about 33.94 kips. The actual computed value will not equal this exactly because the numerical integration is not done that precisely. The number should be within about 5% or so. This number is only approximate because it uses the stress values computed to the plot only. These are sampled at a finite number of discrete points, and some of these points may lie outside the structure. The **INTEGRATE** option does *not* use nodal force information, which would match the applied forces exactly.

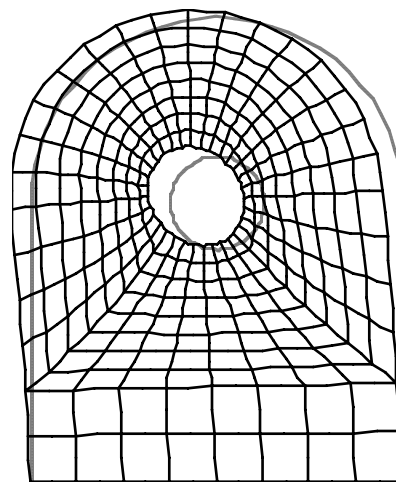

There are a number of other postprocessing features available. When you are done postprocessing, **RETURN** to the main menu.

Crack Location

At this point we will put a crack in the lug. First, however, you should make a restart file. This will save the analyzed uncracked configuration. You may wish to return to this configuration to investigate different initial crack locations.

To initiate a crack, select **MODIFY** option and then the **NEW CRACK** option. There are three crack-face options: 1) **NON-COHESIVE**, a normal traction free crack surface, 2) **COHESIVE** crack models used for rock and concrete, and 3) **GAP ELEMENTS**, which add friction in the crack faces and prevent overlap. For the lug analysis, select **NON-COHESIVE**.

Cracks can start from the edge of a structure(**EDGE CRACK**), or can be completely internal (**INT CRACK**). For this model, select **EDGE CRACK**. You must now specify the location of crack initiation.

The principal tensile stress contours showed the highest stresses at the northeast and southwest locations around the pin hole. These are likely locations for crack initiation. For this analysis, however, we will make things more interesting by starting the crack at the right edge of the hole, normal to the hole. One would start a crack at a location other than the location of the maximum tensile stress if cracking had been observed at the location, or if there are other reasons to believe that a crack is likely at a location (the manufacturing procedure, for example).

To start a crack, it will be easier if you **ZOOM** and **PAN** to get very close to the location of crack placement . Select a node to be the crack mouth (again, you can click in the middle of the pin hole to see the current size of the tolerance box). Select **DONE** after you click on the node. You must now specify the crack tip. You can do this by specifying the exact crack-tip coordinates, or by merely pointing and clicking at some location in the lug. In the present analysis, since we want the crack to be normal to the pin hole, and we want to choose, arbitrarily, an initial crack length of 0.05", you enter the crack tip coordinates at 0.3, 0.0. The program will now ask for the minimum number of elements along the crack extension. It is almost always safe to enter 2 for this question. The actual number of element placed along the crack extension is a function of the local mesh density. Finer initial meshes will cause more elements to be used, and thus give more accurate stress-intensity factors.

The program will now delete a number of elements. You should click anywhere in the FRANC2D window, and the program will insert the crack. When you click again the

program will insert crack-tip elements.

One more click and the program will display a mesh that fills the region near the new crack. The **ACCEPT** option updates the program data structure to include these new elements. The updated mesh will look like this.

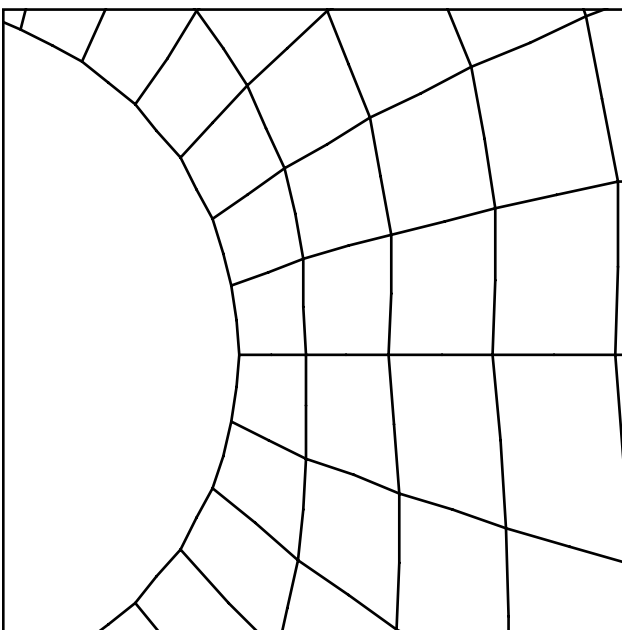

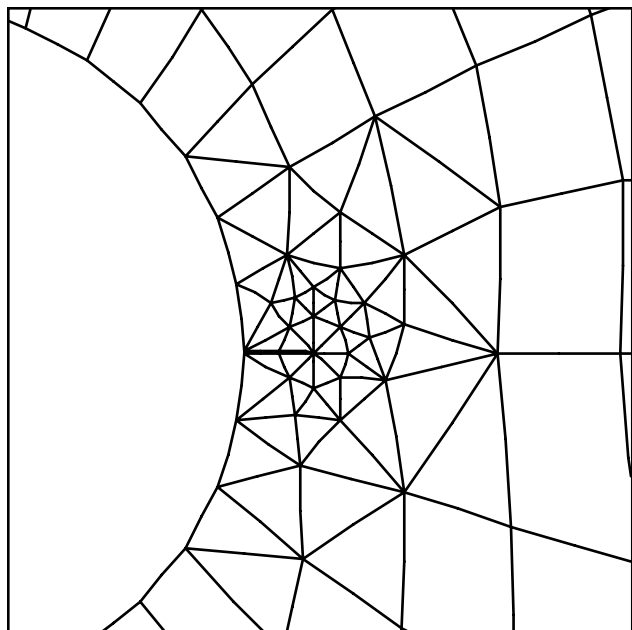

Stress analysis and fracture analysis

Because you now have a new structure, a new stress analysis must be performed. To do this, **RETURN** to the main menu, and select the **ANALYSIS**, **LINEAR**, and **DIRECT STIFF** options.

You can now postprocess the analysis results. If you select the **DEFORMED MESH** option, you should see the crack faces opening. More importantly, we can now compute stress-intensity factors. To do this select the **FRACT MECH** option.

There are three techniques for computing stress-intensity factors in FRANC2D: 1) a displacement correlation technique (**DSP CORR SIF**), 2) a J integral technique (**J-INTEGRAL**), and 3) a modified crack closure integral technique (**MD CRK-CLOS**). All three techniques should give similar K values. For the lug, these are 23.1, 22.9, and 22.5 $\text{ksi}\sqrt{\text{in}}$, respectively.

Crack Propagation

Before we grow the crack, you may wish to save a restart file. To grow the crack, Enter the **MODIFY** page and then select the **MOVE CRACK** option. There are four crack propagation options. We will use the standard method (**STAND METH**). The interface method (**INTFC METH**) can be used when the crack tip is in a bi-material interface. The cohesive method (**COHESV METH**) is used for cohesive crack growth in materials such as rock and concrete. We will use the **AUTOMATIC** method later.

If you select the **STAND METH** option, you will notice a line coming from the crack tip at about a 40° angle. This is the direction in which the program predicts the crack will propagate. This direction is the direction of maximum hoop stress around the crack tip.

There are three options for specifying the new crack tip location. First, you can point and click anyplace on the

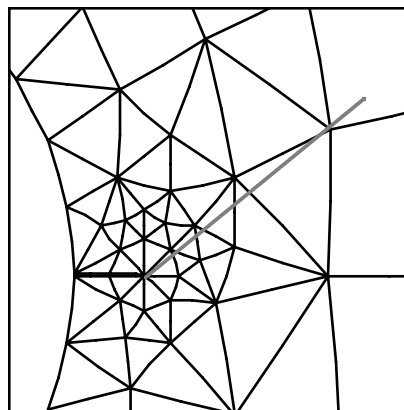

model that you would like. The program will grow the crack to that point. Second, you can use the **KEY POS** option and enter the X and Y coordinates of the new crack tip with the keypad. The third option, that we will use here, is to use the predicted direction of crack propagation, but enter the crack increment. This is the **KEY INCR** option. Select this, and enter 0.05 for the crack increment. (The crack increment is chosen arbitrarily by the user, taking into consideration the gradient of the K 's and expected changes in the crack path. Like creating finite element meshes, this takes some experience, and convergence studies can be used to help gain the necessary insight.) You will need to specify the minimum number of elements along the increment, 2, and the program will remesh just as it did for crack nucleation.

The trial new mesh is shown in orange. You can **ACCEPT** this mesh, or use the **ADD NODES** and **KILL ELEM** options to modify the mesh before it is accepted. The new mesh is shown at the right. Once the mesh is accepted, another stress analysis must be performed.

Crack propagation can be performed automatically also. Enter the **MODIFY** page, select **MOVE CRACK** and **AUTOMATIC**. You can use the **CRACK INCR** option to set the amount of crack growth at each step. For the lug problem use 0.05. Use the **STEPS:** option to set the number of propagation steps. Set that to 5, and select **PROPAGATE** to begin the crack propagation. This may take a few

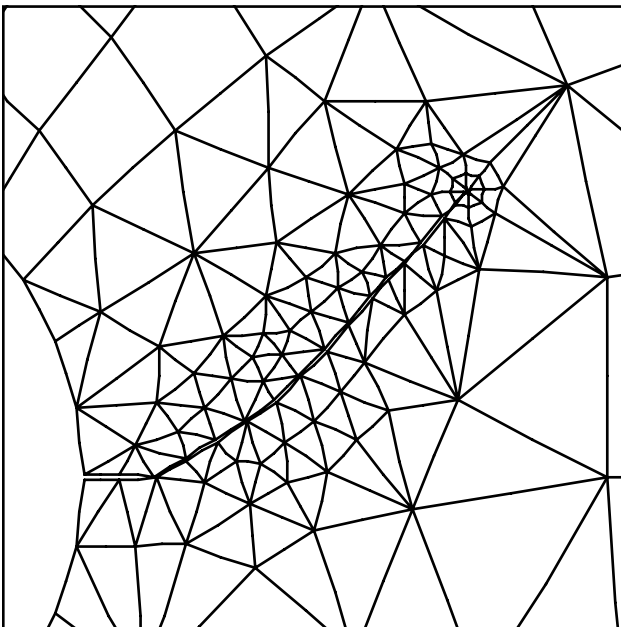
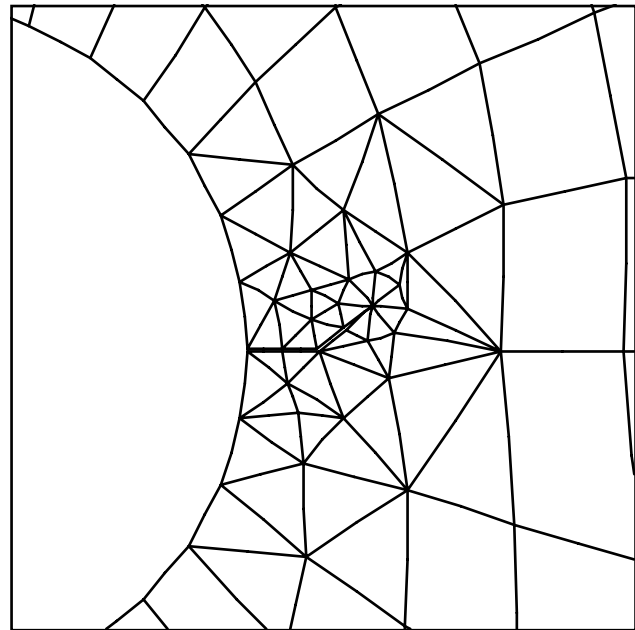

minutes to finish. The final mesh is shown at the left.

When crack propagation is finished, you may wish to **RETURN**, and save a restart file. You may wish to name it something like `lug7c`, for lug with seven steps of crack growth.

Fatigue Crack Growth analysis

To perform a fatigue crack growth analysis of the lug, select the **POST-PROCESS** and **FRACT MECH** options. We will first look at stress-intensity factor histories (**SIF HISTORY**). This allows you plot the K values as a function of the crack length, and to save this information to a file.

Select the **FATIGUE PLTS** option. This allows you to perform a simple fatigue life analysis based on the Paris model. This model states that the crack growth rate is an exponential function of the stress-intensity factor range:

$$\frac{da}{dN} = C(\Delta K)^m .$$

C and m are material specific input parameters. Within FRANC2D, only mode I values of the stress-intensity ranges are used. The crack length is the distance along the arc length of the crack.

Select **SET C**, and enter a value for the constant in the Paris expression. For the titanium alloy we can use a value of 0.114E-8. Use **SET m** to set the exponent to 3.088. The **CYCLE PLOT** option will create a plot of the number of load cycles as a function of the crack length. For the lug problem, you can see that it takes about 3,000 cycles for the crack to grow from 0.05" to 0.35" inches.

The Paris model is very simple and may not be appropriate for some materials, non-zero load ratios, and very high or very low K ranges. In many cases it is more appropriate to extract a K vs a history computed within FRANC2D, and use this information with a more sophisticated growth model.

The final crack length of 0.35" was chosen arbitrarily. The final crack length you will use will depend on the purpose of the analysis. If you are interested in when the lug fails fatigue, you would continue to grow the crack until the computed K 's are greater than K_{Ic} for the material. If you have observed a 0.05" crack in a lug that is scheduled for replacement in less than 3,000 cycles, the structure is probably safe. If you have a requirement that cracks should be no longer than 0.35", then your inspection interval should be less than 3,000 cycles. In all cases, the program allows you to continue to grow the crack and reperform a fatigue crack growth analysis for any crack length.

FRANC2D Menu Reference Guide

This section of the manual describes the menu options available in the FRANC2D program. These are grouped as: the main page, preprocessing functions, modification functions, postprocessing functions, and fracture mechanics functions. This follows the organization of these options in menu pages in the program.

THE MAIN PAGE

One begins and ends a work session in FRANC2D on the MAIN PAGE as shown in Figure R-1. The menu on this page contains all the principal control functions for navigating through FRANC2D. Each of these will now be described.

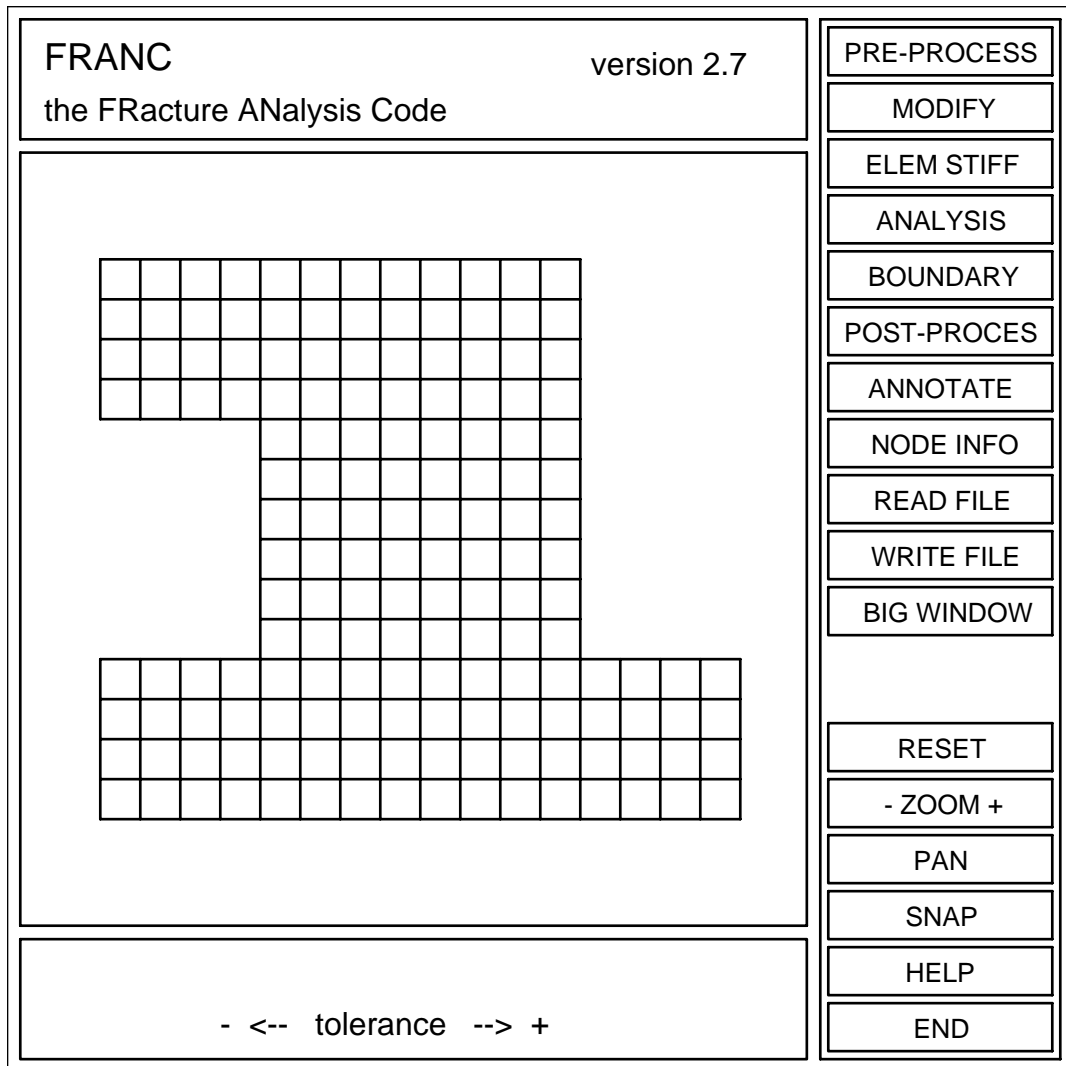

Figure R-1. The FRANC2D main page.

PRE-PROCESS

This button activates the pre-processing page whose functions are described in detail in the PREPROCESSING FUNCTIONS section, below.

MODIFY

This button activates the modify page whose functions are described in detail in the MODIFICATIONS FUNCTIONS section, below.

ELEM STIFF

This button is used to compute element stiffnesses. FRANC2D automatically computes these for all new elements added during manual or automatic remeshing. *Therefore, there are only three instances in which this function is required:*

1. Whenever a new material property set is created and assigned to elements.
2. Whenever a new problem with a different problem *type*, eg. changing from plane stress to plane strain, is input via the **READ FILE** function, the element stiffnesses for the new problem should be recomputed.
3. When a *.sdb file has been deleted, possibly to save space. The element stiffness matrices must be regenerated before the problem can be reanalyzed.

ANALYSIS

This button activates the ANALYSIS PAGE which contains three options: **LINEAR**, **MATerial NONLINear**, and **EQuation NUMBER**. The user should hit this button when the preprocessing stage is complete and a solution is sought.

LINEAR invokes the linear analysis menu that give two additional options: **DIRECT STIFF** and **DYNamic RELAX**. **DIRECT STIFF** invokes a standard Gauss elimination type solver for linear problems. **DYN RELAX** invokes a dynamic relaxation solver used for problems containing gap elements.

MATerial NONLINear invokes a menu that gives the options used for nonlinear problems. These include the **LOAD STEPS**, stopping **TOLERANCE**, **SOLVER** type, **SOLVER PARAMeters**, and the **ANALYSIS** option.

EQuation NUMBER displays the equations associated with each degree of freedom.

BOUNDARY

This function allows the user to suppress the display of the mesh. It toggles between display of the boundary of the structure only and the entire mesh.

POST-PROCESS

This button activates the POST-PROCESSING PAGE whose functions are described in detail in the POSTPROCESSING FUNCTIONS section, below.

ANNOTATE

This button activates the ANNOTATE PAGE which allows the user to see element (Face, in topological jargon), node, and edge numbers, fixity conditions, and the location of crack tips. Each of the buttons on this page toggles the item displayed on-and-off.

NODE INFOrmation

This button allows the user to see information about an individual node. When a node is hit, its number, coordinates, equation numbers, and displacements for each load case are displayed in the *program control (terminal)* window.

READ FILE

This button allows the user to input another problem, or restart the current one, without terminating a FRANC2D session. When the button is hit, the request for this function must first be **CONFIRM**ed or **REJECT**ed. If confirmed, the name of the desired file is input into the *program control (terminal)* window via the keyboard.

WRITE FILE

This button allows the user to save the current problem for later reuse. The problem is given a file name in the *program control (terminal)* window via the keyboard.

BIG WINDOW

This button allows the user to enlarge all windows controlled by FRANC2D to approximately one-third larger than their default size.

(NOTE: This function is inoperative with the X-Window version of FRANC2D)

RESET

This button allows the user to **RESET** the original image of the entire structure in the *operations window*. It is convenient to use after the **PAN**, **ZOOM**, or **MAGNIFY** functions described below.

- ZOOM +

This button allows the user to enlarge (+) or shrink (-) the size of the image of the structure in the *operations window*. The button itself is a rheostat: hitting at the far right (left) area of the button causes rapid enlargement (shrinking). Hitting just to the right (left) of its center causes slow enlargement (shrinking). An incremental change in the size of the image occurs with each click of the mouse button.

The **ZOOM** function is one method of enlarging the size of the image. Another is described next within the **PAN** function.

PAN

This button allows the user to translate the image of the structure within the *operations window*. *The image will translate towards the point in the operations window at which the cursor is placed when the mouse button is clicked.*

When this button is hit, a new menu appears with two buttons: **QUIT** and **MAGNIFY**. **QUIT** returns one to the Main Page. The **MAGNIFY** function is the second, more rapid, way to *enlarge a portion* of the image of the structure in the *operations window*. Two points defining the opposite corners of a box around the area to be enlarged are requested. The *smaller* the distance between these points, the *greater* will be the magnification.

SNAP

This button creates a hardcopy image of the *operations window*. The file can be created in PostScript, HPGL, or HP Paintjet format (the additional program pjet must be used for Paintjet files).

HELP

The on-line **HELP** facility is currently inactive.

END

Hitting this button is the first step in terminating a session with FRANC2D. The next step is to hit the **CONFIRM** button which then appears. If the **END** button is hit mistakenly, hitting the **REJECT** button which follows will return the user to the Main Page.

PREPROCESSING FUNCTIONS

It should be understood that FRANC2D does not create the original mesh. The user must create the model, without any cracks, by means of an external mesh generator. CASCA has been developed to create original mesh files that can be read into FRANC2D directly. Translators are available for other mesh generators such as PATRAN and COSMOS. All other preprocessing functions can be performed within FRANC2D.

In the preprocessing stage the user is able to create/modify the boundary conditions (known displacements, loads, stresses or strains), define/undefine materials (one model can consist of several different materials) or define/undefine crack tips. The pre-process command is the upper most one on this menu. By hitting this button, one moves onto the preprocessing menu page. The options here are, from top to bottom: **FIXITY**, **INTerFaCE FIXity**, **LOADS**, **MATERIAL**, **CRACK DEFinition**, **SINGULARITY**, **USER DEFINED**, **INTerFaCe TOUGHness**, and **PROBLEM TYPE**. The following is a description of each of these commands.

FIXITY

This command enables the user to **FIX** (or **FREE**) known zero displacement degrees-of-freedom (DOF). These processes can be made node-by-node, or along edges of the boundary. It is possible to fix/free the **X-DOF**, **FIX INdependent X**, the **Y-DOF**, **FIX INdependent Y**, or both, **FIX INdependent XY**, for the case of individual nodes, or **FIX EDGE X**, **FIX EDGE Y**, **FIX EDGE XY**, for edges.

The first time this command is selected, the fixities produced by the external mesh generator or by a previous run of FRANC2D are shown. This is done graphically by means of the letters X, Y, or XY displayed on the restrained nodes. If it is desired to **FREE** a previously fixed node or edge segment, one only needs to reselect that node or edge to toggle the fixity off.

The procedure for picking a node consists in positioning the cursor on the desired node and clicking the button once. The first time this is done, a square will appear at the cursor's location, and a search will be made for the node inside that box. In order to select only the desired node, it may be necessary to reduce or enlarge the size of the box. A prompt will now appear in the message window: "**tolerance**" with minus and plus signs. By clicking the cursor on the proper side, plus or minus, the box will be enlarged or reduced to surround only the desired node.¹ In the case of individual fixities, once a node, or series or nodes, is selected, it is necessary to point to the **DONE** command in the bottom section of the menu to return to the new fixity

¹ The cursor tolerance feature is active in the prompt window whenever it may be needed, even if it does not appear in the window explicitly

option. Once the **DONE** option is selected the fixities are drawn graphically, so the user can accept or reject those shown.

An edge specification consists of selecting the initial, adjacent and final nodes along the segment for which fixity is desired. The specification of the adjacent node informs FRANC2D of the direction one wants to follow along the edge. *It should be noted that FRANC2D uses only quadratic order elements (Q8, 8-noded quads, and T6, 6-noded triangles, and I6, 6-noded interface elements), so the "adjacent" node may be a midside node.*²

INTeRFaCE FIXity

This function is inoperative in version 2.7 of FRANC2D.

LOADS

This command allows the user to input various types of loads into load cases. Up to six load cases may be input, and any number of load types may be present in a load case. In addition to the usual FEM load types, it is also possible to apply variable pressure to portions of a crack. The options are: **-CASE+**, **DELETE CASE**, **POINT LOAD**, **DIST LOAD**, **BODY LOAD**, **IN-SITU LOAD**, **THERMAL LOAD**, **RESIDL LOAD**, **APPLD DISP**, **X BOTH Y**, and **MORE OPTIONS**. Options available by selecting **MORE OPTIONS** are **EDG CRK PRESS** and **INT CRK PRESS**. Following is a description of each of these commands.

-CASE+

This command toggles between different load cases. The loading conditions for each case are displayed in the *message window*.

DELETE CASE

DELETE CASE deletes all loads associated with the currently displayed load case.

POINT LOADS

² The location of midside nodes may be observed by using the ANNOTATE button on the main page. After selecting this button, select the NODES button. Numbers will appear adjacent to the nodes. (Note: these numbers may appear to be unordered and far too large. This is because they represent topological entities and not node numbers in the usual FEM sense)

This command allows the user to specify the location and magnitude of point loads. After hitting this menu button, the user is prompted for the magnitudes in the X (or RADIAL) and Y (or AXIAL) directions. These are input via the *keypad*³ which appears at the bottom of the menu window. To select a numerical value, the cursor is positioned on the desired number and clicked. This will display the number in the *keypad* display window. If the number is correct, the keypad **ENT** key is then clicked. If the number is incorrect, it is possible to correct it with the *keypad* **ARROW** key. Sign change and exponentiation may also be performed in the usual way with the *keypad*.

After the magnitudes are entered, the cursor is clicked on all the nodes which are to receive them. Any number of nodes may receive point loads. To finish this option **DONE** is then clicked.

DIST LOAD

With this option the user can enter different boundary pressure types. According to their effect on the sides of the loaded elements, these types are classified as **NORMAL**, **SHEAR**, **X GLOBAL** and **Y GLOBAL**. The distribution of the loading can be **CONSTANT**, **LINEAR** or **QUADRATIC**, for all the four types.

The elements to be loaded are indicated by the specification of initial, adjacent and ending nodes, as in specifying fixities. In the input of initial or adjacent nodes, if the cursor box is too large, it is possible that more than one node may be selected. In this case you will be asked which node is desired through the **TOGGLE NODE** menu button. When the correct one is indicated by arrows, it is selected by the **ACCEPT** menu button.

The magnitudes of the distributed load are input via the *keypad*. **LINEAR** asks for the values of the pressure at the initial and the ending point of the distribution. **QUADRATIC** asks for the magnitude at the initial and ending points and request the location, as a fraction between 0.0 and 1.0, of the third pressure point, as well as its magnitude. The calculated values of the equivalent nodal loads are then displayed adjacent to all loaded nodes.

BODY LOAD

This command allows the user to specify X and Y components of acceleration over the entire structure. Input of the value of acceleration is via the *keypad*. The

³ The keypad becomes active many times during the running of FRANC2D. This allows interactive input of numerical values. (Note: this is the keypad in the menu window and not the keypad on the keyboard)

units for acceleration are assumed to be consistent with those used for material density on the MATERIALS PAGE. For axisymmetric analyses, the angular acceleration (in radians/second) is entered along with the axial component of the linear acceleration.

IN-SITU LOAD

With this command the user is able to introduce stresses or strains caused by the placing of the body in its environment, or by residual or initial loadings. The stresses/strains can be introduced in the **WHOLE MESH**, to different **ELEMENTS**, or by **MATERIAL** types. The program will request the values of the normal stresses/strains and for the shearing stress/strain in the global X-Y system via the *keypad*.

THERMAL LOAD

This command allows the application of thermal-induced loading to the structure. The options for specifying temperature distribution are reading an **EXTERNAL**ly described **DISTR**ibution, an **ELEM**ent based **DISTR**ibution, or a **MATERIAL** based **DISTR**ibution.

Temperature distributions may be assigned as an arbitrary scalar field through **EXTERNAL DISTR**ibution. If this option is selected, an ASCII file (*.tdi) containing the temperature distribution information must have been generated. The format of these files is specified in Appendix B. The information is compiled for later use, and a new file with the same name, but with a .tdc extension, is produced automatically. Temperatures are specified in a pointwise basis. Points along the external boundary of the structure, as well as interior ones can be used to create a distribution mesh. The following functions are used to compile the information, display the information, show the distribution mesh, show the structural mesh, display load case information, and delete the load case, respectively: **COMP**ile **DISTR**ibution, **DIS**play **DISTR**ibution, **DISTR**ibution **MESH**, **STRUC**Tural **MESH**, **LOAD CASE**, and **DE**LETE. If compiled information is not available, the button **COMP**ile **DISTR**ibution must be used first.

The temperature distribution can also be generated on an element-by-element, **ELEM**ent **DISTR**ibution, or material-by-material **MATERIAL DISTR**ibution basis. For an element distribution, the user has the option of specifying up to 10 regions with different temperatures, but there is only one coefficient of thermal expansion used for the entire model. For a material distribution, one can assign a different coefficient of thermal expansion to each material, but only one temperature is specified for the entire model. *Internally these two features share variables, so they cannot both be used in a single model.*

RESIDuaL LOAD

This command allows the application of residual stress and strain loading to the structure. The initial stresses or strains are specified at a number of boundary and interior points on the structure. This information is kept in an ASCII file (*.rsi). The program then interpolates residual stresses or strains over the domain of the structure, and computes residual loads for each node. The .rsi file may be defined by the user or obtained through a materially nonlinear analysis. See the Postprocessing functions for more details.

The following functions are used to compile the information, display the information, show the distribution mesh, show the structural mesh, display load case information, and delete the load case respectively: **COMPile ReSidual DISTribution**, **DISPlay ReSidual DISTribution**, **DISTribution MESH**, **STRUCTural MESH**, **LOAD CASE**, and **DELETE**. If compiled information is not available, the button **COMPile DISTribution** must be used first.

INTeRFaCE LOAD

This command allows the user to specify pressure in interfaces represented by interface or gap elements. The options are **NORMAL**, **SHEAR**, **GLOBAL X**, **GLOBAL Y**. Input of magnitudes is via the *keypad*.

APPLieD DISPlacement

This command allows the application of non-zero displacements to structural DOF's. The values can be specified for individual nodes, **Point DISP**, or along an edge, **EDGE DISP**. Input of magnitudes is via the *keypad*. *Note that applied displacements must be treated as a separate load case.*

EDGE CRaCK PRESSure

This command is one of the unique characteristics of FRANC2D. It allows the application of variable pressure along part of an edge crack. The user can choose **CONSTANT**, **LINEAR**, **QUADRATIC** or **LAGRANGIAN** distribution of pressure.

- **CONSTANT:** Asks for the pressure value to be applied to the entire crack. The tip node for the pressurized crack must be indicated.
- **LINEAR:** Asks for the pressure values at the crack mouth and at the end of the pressurized crack section. Then the user enters 0.0 for a linear variation, or normalized location (0-1.0) for a third point. If a third point is selected, then the value of pressure at that

point is requested. After this the fraction (0-1.0) of the crack length, starting from the crack mouth, to be pressurized is input. Finally, the tip node for the pressurized crack must be indicated.

- **QUADRATIC:** The instructions for this type of distribution are identical to the **LINEAR** case.
- **LAGRANGIAN:** With this option, the pressure distribution can be of any form. The data can be entered via a **DATA FILE**, in which case the file name is requested, or via **KEY IN DATA**. With this latter option, the number of points needed to define the curve is requested, and for each point the absolute location along the crack and the corresponding pressure must be entered.

INTernal CRacK PRESSure

This command is similar to the **EDG CRacK PRESS** command described above, except that it works for internal, rather than edge, cracks.

X BOTH Y

Clicking in the X(Y)-side of this button causes suppression of the *display* of the Y(X)-component of all nodal loads.

MATERIAL

This option enables the user to specify material type and properties. A separate window is created to echo the material properties selected. Default, isotropic, elastic properties are displayed in this window initially. Besides the most common **ELASTic ISOTROPIC** and **ELASTic ORTHOTROPIC** types, the user can define a linear or a Non Linear **INTERFACE** material. **ElasticPLASTic ISOtropic** materials are also available (elasticplastic orthotropic elements are not currently active). A constraint type “element” is also available through **GAP ELEMents**. It should be noted that a gap element is not actually a finite element, but simply a constraint used for the surface sliding algorithm.

The first button in the command menu, - **MAT** +, scrolls through all existing material sets. To create a new material set, hit **NEW MAT**. You will then be prompted for the material type desired. Whenever a material property set is displayed in its own window, the abbreviation for each of the corresponding material properties appears as a button on the control menu. For example, for an **ELASTic ISOTROPIC** type the command zone has the **E** (Young’s modulus), **Nu** (Poisson’s ratio), **THICKNESS**, **KIc** (Plane strain fracture toughness) and **DENSITY**. If the

user wishes to modify a value, hitting that button will cause the *keypad* to appear for entering the new value.

The **SWITCH ELEMENT** button allows the user to change the initial specification of an element's material. When this is selected, the mesh is shown with the material type number enclosed in each element. Clicking into an element will change the original properties to the current property set number shown in the *auxiliary* material information *window*. The button **SWITCH ALL** allows the user to change the material specification for all elements to the current one.

For an **ELASTIC ORTHOTROPIC** material, the requested (and displayed) properties are: **E1**, **E2**, **E3**, (Young's moduli in the principal material directions 1,2,3 respectively), **G12**, (Shear modulus in the 12 plane), **Nu12**, **Nu13**, **Nu23**, (Poisson's ratios in their respective directions), the angle **BETA** (the angle in degrees between the global X-axis and the 1-principal material direction, measured positive CCW), **THICKNESS**, **KIc1** and **KIc2** (the principal material toughnesses in the 1- and 2-directions) and **DENSITY**. The toughness is assumed to vary elliptically between **KIc1** and **KIc2**.

For an Elastic **PLASTIC ISOTROPIC** material type, the following properties should be specified: **E** (Elastic Modulus), **Nu** (Poisson's ratio), **HARDENING MODULUS** (only linear hardening models are available), **KINEMATIC HARDENING** (Kinematic hardening flag), **YIELD STRESS**, **PLASTICITY CRITERION** (currently on von Mises is available), **THICKNESS**, **KIc**, and **DENSITY**.
Note: the current elastic plastic capabilities of FRANC2D are rudimentary and not fully tested. They are scheduled for substantial revision, so the current capabilities are not described in detail in this manual.

For an **INTERFACE** material one has to define the **SHEAR** and **NORMAL** stiffnesses in units of stress per unit length. Values for these stiffnesses are input via the *keypad*.

As mentioned above, the **NonLinear INTERFACE** button defines a combination of nonlinear models for normal and shear stiffnesses. The **NORMAL** button is used to define the normal stress versus crack opening displacement model. The **SHEAR** button is used to specify the shear stress versus crack sliding displacement model, and **THICKNESS** is used to input the thickness. The **SWITCH INTERFaCe** button is used to change all interface models to the current one.

The available models for normal stress/COD are **LINEAR**, **LINear-SOFTENing**, **BILINear-SOFTENing**, **TENSion CUT OFF**, and **EXPonential-SOFTening**. The input for these options is made in the *program control* window via the keyboard. For example, if the user selects **LINEAR** then in the *program control* window (remember that it is necessary to click in some part of that window in order to activate it !) will appear the message:

This command allows the user to specify nodes to define/undefine as crack tips. It is useful for situations in which the mesh around a crack is rebuilt manually, and it is desired that the program treat the node as a crack tip.

SINGULARITY

This command moves all the elements adjacent to the specified node from(to) the element mid-side position to(from) the quarter-point position. It is useful for situations where you do not wish to use quarter-point element around a crack tip. It may also be used to create a point of singularity under a point load, at a re-entrant corner, etc., *although the order of singularity created may not be correct.*

USER DEFINED

This option gives access to a number of obsolete features that are not supported in the current version.

INTerFaCe TOUGHness

This command allows the user to define a toughness model for a bi-material interface. The model is used in the interface propagation option under **MOVE CRACK** (Modify page). Bi-material interface models specify the critical strain energy release rate as a function of the load angle, $\tan^{-1}(K_{II}/K_I)$. The model is input as a series of data pairs.

PROBLEM TYPE

This command allows the user to change the current problem type among plane stress, plane strain, and axisymmetry. *Remember to recompute element stiffnesses with the **ELEM STIFF** option if the problem type is changed.*

MODIFICATION FUNCTIONS

The Modify Page allows the user to modify both the geometry of the structure and the mesh. Modifications may involve addition/deletion of individual elements, dragging of nodes, or initiation and propagation of cracks, and creation of material interfaces or boundary contacts.

ADD Q8, ADD T6, KILL ELEM, DRAG NODE

These buttons allow the user to alter the mesh by adding and deleting individual elements and dragging nodes. These buttons are intended for minor mesh modification when the user does not wish to exit the FRANC2D code and re-run the mesh generator. When adding elements, be sure to first kill any elements lying in the region where the new elements are to be placed. The act of killing elements results in the creation of new boundary segments which can be seen by clicking on the **BOUNDARY** button during element deletion. Note that midside nodes, although not displayed, can also be dragged.

The following example illustrates the use of these modification buttons. Suppose the user wished to replace a sharp re-entrant corner of the latch, Figure R-2, with a filleted corner.

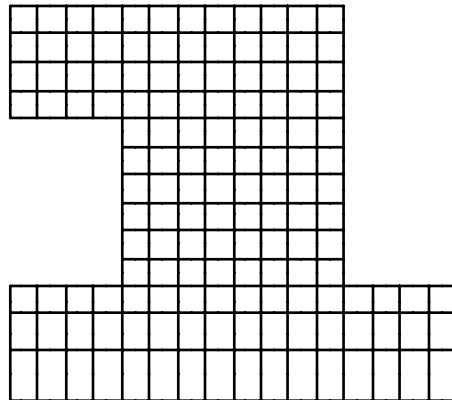

Figure R-2. Initial mesh for the latch example problem.

Such a minor modification can be made inside of FRANC2D using the modification buttons as follows:

DRAG the corner node to its new position, Figure R-3a. To eliminate the large distortion of the elements about this node replace the three Q8 elements with more T6 elements. The **ADD** operators do not allow the splitting of any existing element sides, and new elements must share at least one side with an existing element. Keeping these two restrictions in mind, one can remesh this region by first deleting the two Q8 elements as shown in Figure R-3b. One can then add the T6's by

starting from the existing edge at the top of the deleted region, Figures R-3c and R-3d. The lower Q8 element is now **KILLED**, Figure R-3e. Finally, five T6's are added, leaving one with the final mesh shown in Figure R-3f.

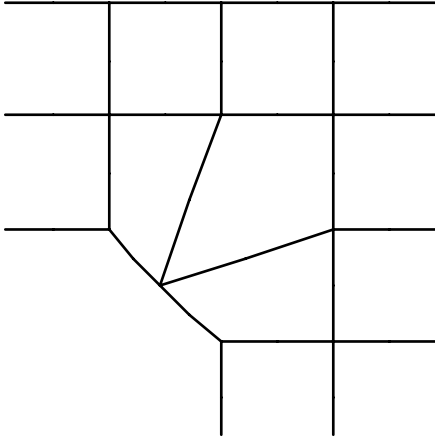

Figure R-3a. The re-entrant corner after **DRAG**ging of corner node.

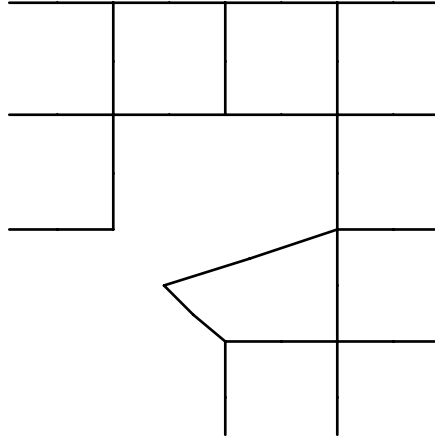

Figure R-3b. Deletion of two Q8 elements.

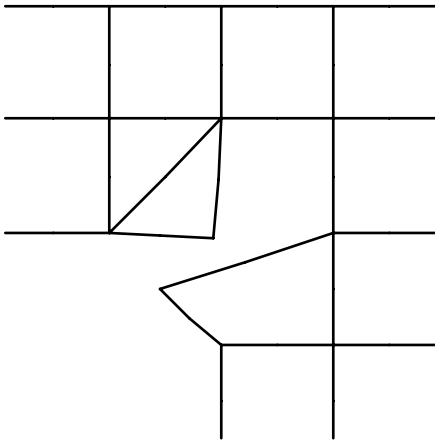

Figure R-3c. Addition of two T6 elements.

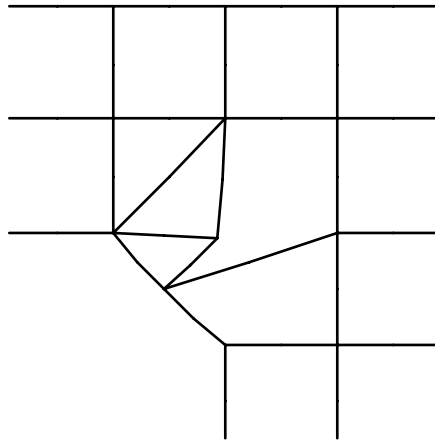

Figure R-3d. Addition of one more T6 element.

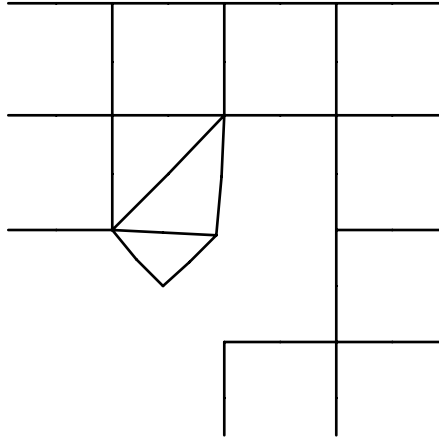

Figure R-3e. Deletion of the lower Q8 element.

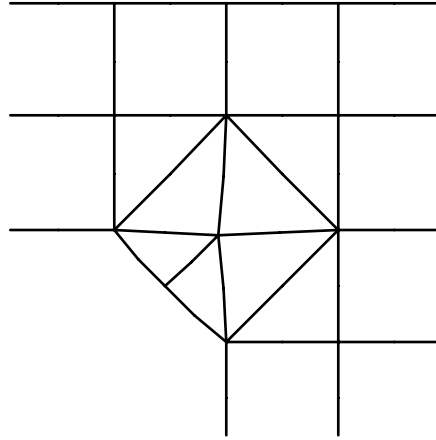

Figure R-3f. The re-entrant corner after remeshing.

NEW CRACK, MOVE CRACK

These buttons relate specifically to fracture mechanics operations. They allow the user to initiate and to propagate edge or internal cracks.

Before describing the steps necessary to initiate and propagate cracks, a note on semantics is necessary. As a crack grows, it creates new boundary segments, either by moving into the structure from the external boundary, or by initiating fully internal to the body and starting a new internal boundary.

The **NEW CRACK** button allows the user to initiate a new crack. The crack can be a **NON-COHESIVE** crack (a normal crack with traction free crack faces), a **COHESIVE CRACK** (with interface elements in the crack faces), or a crack with **GAP ELEMENTS** in the crack faces (which inhibit interpenetration of the crack faces). To use the **COHESIVE** or **GAP ELEM** options, appropriate interface or gap element types must have first been created in the Materials pages.

The **MOVE CRACK** button allows the user to propagate an existing crack by locating a crack tip node at a new location. Four options are available for propagation: **STANDARD METHOD** (for non-cohesive cracks, step by step), **INTERFACE METHOD** (for cracks in a bi-material interface that do not contain interface elements), **COHESIVE METHOD** for cohesive crack propagation, and **AUTOMATIC** crack propagation (for non-cohesive cracks).

With the **NEW CRACK** button, after specifying whether the crack is cohesive or not, the user may initiate a crack from a boundary using **EDGE CRACK**, or completely internally using the **INTERNAL CRACK** option. For an edge crack, the crack must start from a corner node of an element on the boundary of the structure.

The new crack tip can lie anywhere within the structure. When initiating an internal crack, both crack tips must lie somewhere in the interior of the structure⁴.

Once a crack is specified, the program will delete elements near the projected crack path (maintaining both material and structural boundary information), insert a rosette of eight, quarter-point, T6 elements about the crack tip, and then mesh the deleted region using a quad-tree algorithm which produces well-formed T6 elements. The automatically generated mesh is shown to the user for approval.

The user may **ACCEPT** the mesh as-is, or re-run the re-meshing algorithm with altered initial conditions. The user may **ADD NODES** to the deleted region. (The algorithm will use these nodes along with additional nodes which it will generate automatically.) The user may also **KILL ELEMENTS**, thereby enlarging the deletion region and giving the remesh algorithm more space in which to operate. Finally, the user may **REFINE INTERFace** which will add more nodes to all the material interfaces in the deletion region. *One rule of thumb to keep in mind is that the remeshing algorithm works best when the characteristic lengths of the elements in the region into which the crack is propagating are about the same as the length of the crack increment.*

The following example illustrates crack placement and propagation. To initiate a crack at the re-entrant corner of the latch, use the **NEW CRACK** button. Specify the re-entrant corner node and then specify any point internal to the body. The elements near the crack path are deleted automatically, but boundary information is maintained, Figure R-4a. The crack is then added to the boundary automatically, Figure R-4b. A rosette of eight T6 elements is inserted about the crack tip automatically, Figure R-4c. A trial mesh is generated, Figure R-4d.

The user now has the option of accepting this mesh or modifying the re-meshed region and re-running the algorithm. Additional nodes may be added to the region, or the region may be enlarged by killing elements. Figures R-4e and R-4f show the deletion of elements to expand the region and the resulting mesh.

⁴ A current limitation of FRANC2D is that a tip of an internal crack may not reach the boundary. The crack may approach arbitrarily closely to the boundary and FRANC2D will continue to decrease the size of the crack tip elements appropriately. However, at some point, unless manual remeshing of the boundary is performed, the elements between the crack tip and the boundary will become highly distorted.

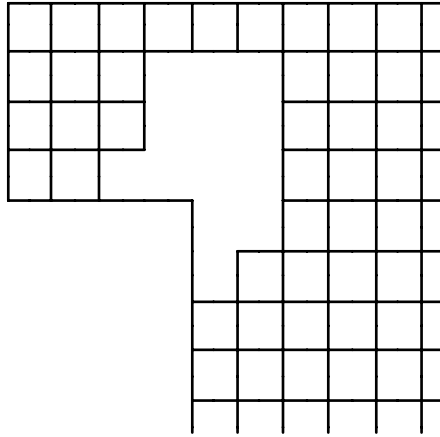

FigureR-4a. Automatic deletion of elements near crack path.

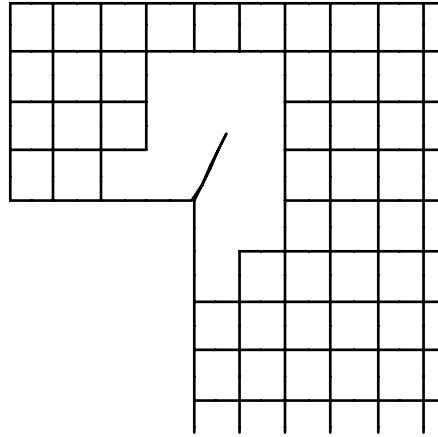

Figure R-4b. Addition of the specified crack.

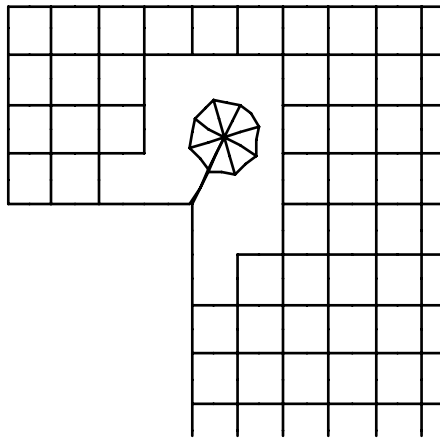

Figure R-4c. Insertion of rosette of T6 elements about crack tip.

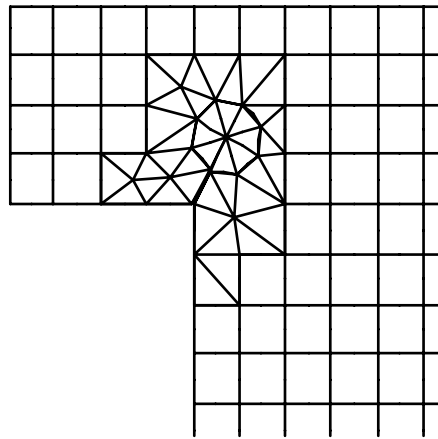

Figure R-4d. Automatically generated trial mesh.

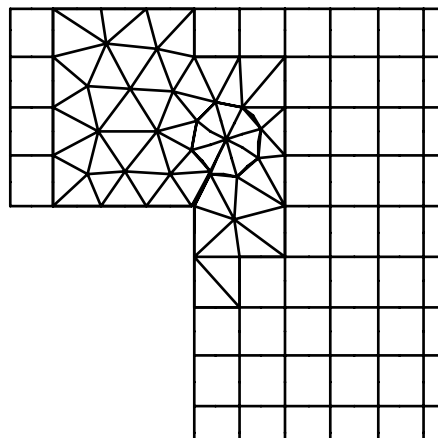
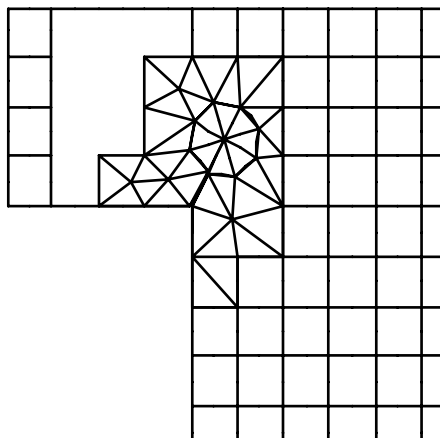

Figure R-4e. Enlargement of deletion region via use of the **KILL ELEM** button during remeshing phase of crack propagation.

Figure R-4f. New mesh for the enlarged deletion region.

Use of the **ADD NODES** button is illustrated for the mesh generated during initiation of an internal crack, Figure R-5a. Nodes are added to give the new mesh of Figure R-5b.

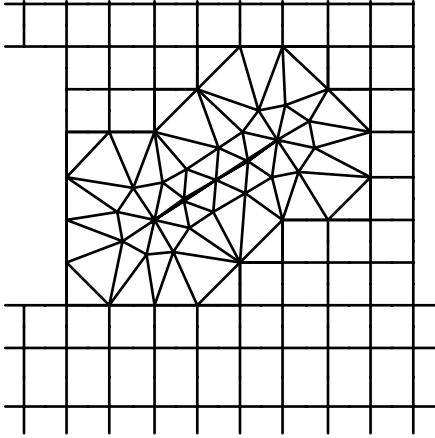

Figure R-5a. Automatically generated mesh for placement of an internal crack.

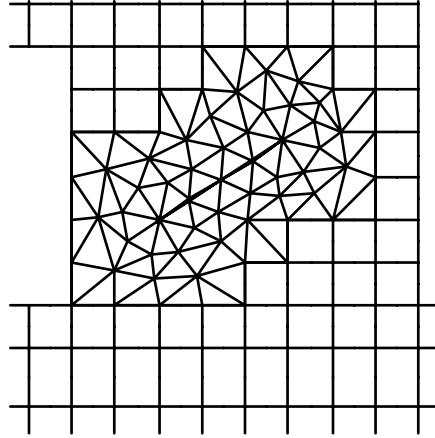

Figure R-5b. Mesh after addition of more internal nodes.

SHOW ANGLE

The **SHOW ANGLE** button displays the computed direction of propagation for a crack tip. The analysis results of the cracked configuration are used to compute the mode I and II stress intensity factors which are used in a closed-form expression that determines this direction from the maximum circumferential stress around the crack tip. During crack propagation, if the analysis results are available, this suggested propagation angle is also displayed giving the user the option of propagating the crack by an incremental distance along that line.

INTERFaCe OFF/ON

The **INTERFaCe** button changes how the mesh is displayed. When this is set to the **ON** position, the mesh is displayed normally. When this button is set to the **OFF** position, the boundary of the object, along with the bi-material interfaces, are displayed in white, while the remaining mesh edges are displayed in orange.

ADD INTERFaCe

The **ADD INT** button allow the user to modify the structure by the addition of an interface using *linear* interface elements. The interface must start and terminate on the boundary of the structure. It is inserted element-by-element following the instructions which appear in the prompt window. *Note that a material property set for the interface must first be created via the preprocessor's MATERIAL button before this function can be activated.*

ADD NonLinear INTeRFaCe

The **ADD NL INTRFC** button allow the user to modify the structure by the addition of an interface using *nonlinear* interface elements. The interface must start and terminate on the boundary of the structure. It is inserted element-by-element following the instructions which appear in the prompt window. *Note that a material property set for the interface must first be created via the preprocessor's MATERIAL button before this function can be activated.*

MORE OPTIONS

Makes the **SUBDIVIDE**, **T6 TO CQ8**, **CQ8 TO T6**, **ADD GAP ELEM**, and **ADD BIMAT GAP** options available.

SUBDIVIDE

This option allows the user to perform convergence studies by refining the mesh adjacent to a crack tip. The original T6's are shrunk and additional Q8's are added. The elements about the original crack tip are shown in Figure R-6a. The resulting mesh after subdividing with a ratio of 0.3 is shown in Figure R-6b.

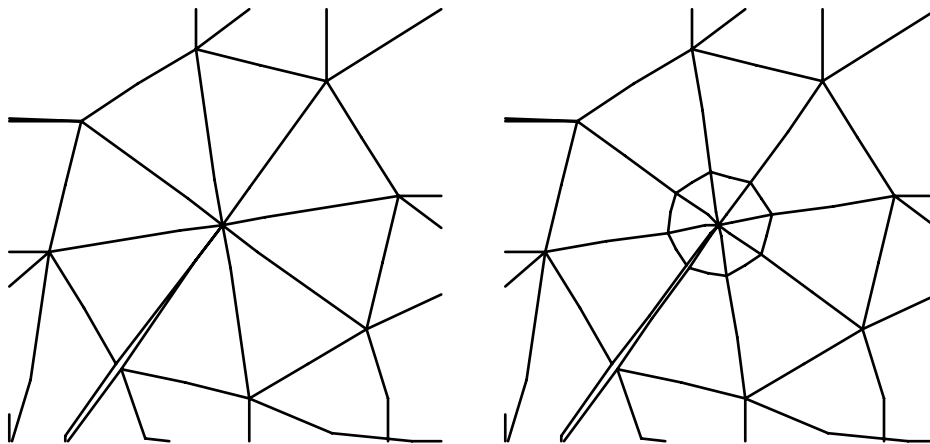

Figure R-6a. Rosette of eight T6 elements about a crack tip.

Figure R-6b. New mesh after use of **SUBDIVIDE** with ratio of 0.3.

T6 TO CQ8, CQ8 TO T6

These options change crack tip elements from T6 elements used for linear elastic fracture mechanics to collapsed Q8 elements used for elastoplastic fracture mechanics, and back again.

ADD GAP ELEMENTS

This option allow the user to modify the structure by the addition of gap elements. The gap must start and terminate on the boundary of the structure, or form a closed loop. It is inserted element-by-element following the instructions which appear in the prompt window. *Note that a material property set for the interface must first be created via the preprocessor's MATERIAL button before this function can be activated.*

ADD BIMATERIAL GAP

This option allows the user to modify the structure by the addition of gap elements in a bi-material interface. This done by pointing to a portion of a bi-material interface. The program will automatically insert gap elements along the entire interface. *Note that a material property set for the interface must first be created via the preprocessor's MATERIAL button before this function can be activated.*

POSTPROCESSING FUNCTIONS

-CASE+

This button allows the user to select a load case. The remaining functions of this page will be performed for the selected load case.

FRACTure MECHAnics

By hitting this button, the post processor tools related to fracture mechanics analysis are made available to the user. A new page with a menu of options is displayed. See the FRACTURE MECHANICS FUNCTIONS described below.

LINE-PLOT

To invoke the line-plot option, the user is first required to input the starting and ending points of an arbitrary line. The coordinates of these points may be provided by clicking at the desired positions with the mouse or by entering the numerical values of the coordinates via the *keypad*. After the line is specified, Figure R-7, the **DONE** button must be hit. If the user decides to quit this function, he should select the **QUIT** option. The user may then specify **NEW LINE** and repeat the previous step to get a new line of reference.

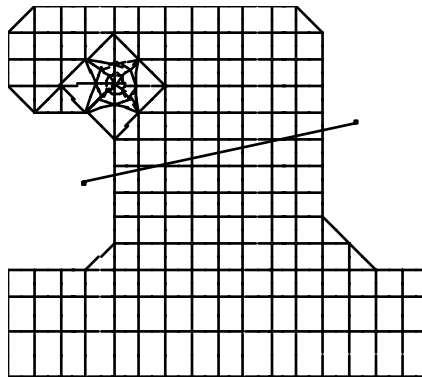

Figure R-7. Path for line plot.

Plots may be displayed along the specified line of **SIGXX**, **SIGYY**, **SIGXY**, and **NORMAL** or **SHEAR** stresses with the options **TOTAL/resid** (so that residual stresses can be visualized as well as total stresses). The upper case text indicates the active mode. In the case of problems with linear-elastic material properties, only total response will be available. If you select one of the options the appropriate distribution of stress is automatically displayed in an *auxiliary window*. The **INTEGRATE** option will compute the equivalent load along the line, and the **FILE** option will store the plot in a file. For the latter, the user is requested to enter the

name of the file in the program control window and then return. It is possible not only to obtain distributions of the same stress component along different lines, but also to display different stress components plots for the same line. The option **QUIT** returns control to the postprocessor page.

CIRCLE-PLOT

To use this option, you are first required to specify the center of the circle along which the plot will be provided. This may be done by simply clicking at the desired position with the mouse, by entering the point coordinates through the *keypad*, or by selecting an existing **NODE**. The **TOTAL/resid** option is available so that, in nonlinear analyses, one can view residual as well as total stresses. Then the radius of the circle is requested. A new menu with the options to be plotted is then generated. **NEW CIRCLE** is available to change the plotting path (in this case center and radius should be provided again).

The options available are **SIGXX, SIGYY, SIGXY, SIGRR, SIGTT, SIGRT, UDISP, VDISP**. X and Y refer to the global axes of reference, while R and T to the local polar coordinate axes. The **INTEGRATE** option is also available. Press the **RETURN** button to go back to the postprocessor page.

RADIAL-PLOT

To use this option, select an existing node from which the radial plot will be displayed. The stress is not computed at the selected node, so this option can be used to plot the stress field approaching a crack tip. (If the **LINE-PLOT** option is used, the program may try to compute the infinite stress at the crack tip, causing a computer error). Then the ending point is then input. The ending point may be placed in an arbitrary position. The position of this point is specified with the mouse or through the *keypad* option. A new menu page is displayed with the options for the radial plots. The function **NEW LINE** is available for changing the radial line. The **TOTAL/resid** option is available so that, in nonlinear analyses, one can view residual as well as total stresses.

The user has the options: **SIGXX, SIGYY, SIGXY** (with respect to the global axis) and **SIGRR, SIGTT, SIGRT** (with respect to the local polar system of reference), as well as **UDISP** and **VDISP**. The option **FILE** may be selected to store the displayed plot information in a file. By hitting **QUIT**, the user returns to the postprocessor page.

NODal INTernal FORCE

The force at a node is the sum of the external forces and internal forces from each of the elements adjacent to the node. (These will add to zero, due to equilibrium)

This function calculates the sum of the internal forces exerted on a node by one or more elements adjacent to the node. First the node must be selected. Hit **DONE** to go ahead or **QUIT** to go back to the postprocessor page. A new page is displayed then with the options:

- ADD.SUBJ.FAC** to make an element around the specified node be subjected to the nodal force. The user is expected to click on elements to select them.
- ADD.APPL.FAC** to make an element around the selected node apply the nodal force, and,
- INTER.FORCE** to compute the nodal force.

Hit **RETURN** to go back to the postprocessor page.

STRESS-BAR

The stress bar option displays the **TENS**ile and/or **COMP**ressive stress flow in the structure, by displaying vectors of principal stresses at each gauss point. The user has the option of turning the mesh off by selecting the **BOUNDARY** button. Select **RETURN** to return to the postprocessor page. Figure R-8 shows the tensile stress flow for the example considered. In this case the mesh is turned off.

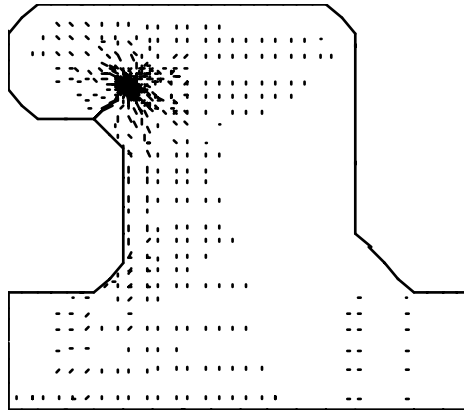

Figure R-8. Tensile stress bars.

CONTOUR

Contour plots of stress components (**SIGXX**, **SIGYY**, **SIGXY**), principal stresses (**SIG 1**, **SIG 2**), maximum shear stresses (**TAU MAX**), effective stresses (**EFF.STRESS**) and strain energy density (**STR.EN.DNS**) may be displayed through this option. The **TOTAL/resid** option is available so that, in nonlinear analyses, one can view residual as well as total stresses.

To make a contour plot, select one of the stress options. A color scale is presented in the *auxiliary window*. The colors of the plot may be changed by pressing the **COLOR SCALE** button and reselecting the stress option.

The contour ranges (maximum and minimum values) can be set with the **SET LIMITS** options. **CLEAR LIMITS** allows you to go back to the stress ranges computed by the program automatically. A contour plot of the maximum principal stresses for the example problem is displayed in Figure R-9.

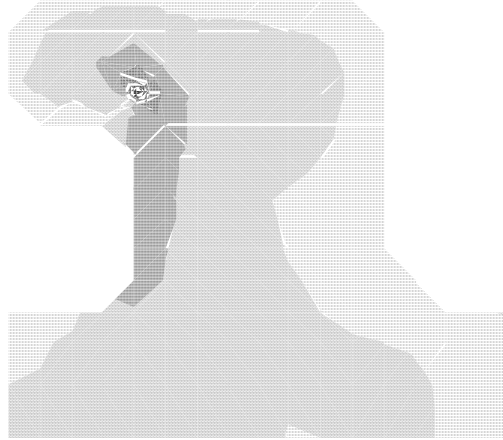

Figure R-9. Maximum principal stress contours.

DEFoRMED MESH

This option provides the deformed shape of the structure for the existing load cases. The **-CASE+** button allows the user to select the load case for which the deformed shape is sought. The **DEFAULTS** option recovers the default values used to build the deformed shapes. The **VALUE** option allows the user to change the magnification factor used. **DEF-DASHED** displays the deformed shape in dashed lines. **DEF-BOUND** displays only the boundaries of the deformed shape. **ORG-OFF** turns off the original structure drawing. **ORG-SOLID** displays the original structure in solid lines. **ORG-FULL** turns on the original mesh. The user must hit **RETURN** to return to the postprocessor page. The deformed shape obtained for the load case 1 of the example problem is shown in Figure R-10.

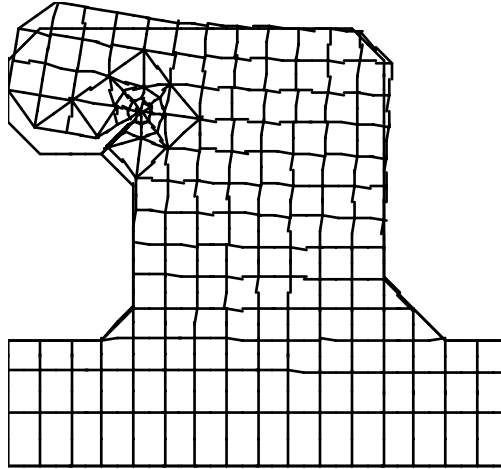

Figure R-10. Example Deformed Mesh.

NODE-INFORMation

This option allows the user to get nodal information such as node number, nodal coordinates, corresponding equilibrium equation numbers, and nodal displacements for distinct load cases. You should click on a node about which information is sought, and then select **DONE** to get the information. The information is displayed in the *program control* window. **QUIT** should be used to cancel the operation.

MULTiple **NODE-INFORM**ation

This option is similar to **NODE-INFO**, but it returns information for all the nodes in the tolerance box. This is useful in cases of zero thickness interfaces, or for node pairs on either side of a crack.

RESidual **STR**ess/**STR**ain **FILE**

This button allows you to create a *.rsi file with the residual stress and strain information available as a result of performing a materially nonlinear analysis. This information is used to define a residual stress/strain load case (see **RESIDL LOAD**).

RETURN

Returns to the main page.

FRACTURE MECHANICS FUNCTIONS

-CASE+

This button allows the user to select a load case to be used by the other available features in this page.

DiSplacement CORRelation SIF

Stress intensity factors for a selected crack are obtained through the Displacement Correlation Technique and displayed in the *auxiliary window*. Values for all the existing load cases are calculated. If there is more than one crack tip, the user must first select one of them.

INTERACTION

When the interaction option is selected, a new menu is displayed containing: Sigma Theta Maximum (**SIG-THETA**, the default), G Theta Maximum (**G-MAX**) and S Minimum (**S-MIN**). These are the Mode I/II interaction theories that are available in the program.

The Sigma Theta Maximum theory states that will move in the direction of maximum circumferential stress around the crack tip when a critical value of the stress is reached⁵. The G Theta Maximum theory states that the crack will move in the direction of maximum energy release rate when a critical value of energy release rate is reached⁶. The minimum strain energy density theory, S Minimum, states that the crack will move in the direction where the strain energy density is minimum, and will move when a critical value is reached⁷

The position in the interaction diagram of each of the crack tips stress intensity factor pairs is displayed in the *auxiliary window*. The user can modify the load factors with the **KEY LOAD FAC** option. The **ADJ LOAD FAC**, is used for quasi-static crack propagation. It adjusts load factors automatically to bring the

⁵ Erdogan & Sih, "On the crack extension in plates under plane loading and transverse shear," *ASME J Basic Engr*, 85, 519-527 (1963).

⁶ Hussain, Pu, & Underwood, "Strain energy release rate for a crack under combined mode I and II," *Fracture Analysis, ASTM STP 560*, 2-28 (1974).

⁷Sih, "Strain-energy-density factor applied to mixed-mode crack problems," *Int J Fracture Mech*, 10, 305-321 (1974).

crack with the highest effective stress intensity to instability. The K_{Ic} material property must be set for the **ADJ LOAD FAC** option to work properly.

SIF HISTORY

The history of the stress intensity factors over the previous steps of propagation is displayed. **KI** or **KII** may be selected. The information can be stored in a file with the option **FILE**.

FATIGUE PLoTS

The Paris crack growth rate model is provided with the history of stress intensity factors. The model parameters may be adjusted. A plot of crack length versus number of cycles is then generated.

J INTEGRAL

This option computes stress intensity factors using an equivalent area formulation of the J-Integral. By default, the program selects the crack-tip elements as the domain of integration. This gives the best results for materially linear analysis. For materially nonlinear analysis, a menu is displayed that allows you to modify the domain used to calculate the J integral.

A completely new domain can be defined with the **DEF DOMAIN** button. This domain must engulf the selected crack tip. Two points defining a box are requested. Elements lying totally inside this box are considered to belong to the domain and are shaded automatically. **ADD ELEM**, **REM ELEM** and **REM ALL** allow the user to modify the domain by adding an element, removing an element and removing all the elements, respectively. By pressing the **EVAL JINT** button, the user can obtain J integral components and stress intensity factors for the defined domain. The **qVALUES** button allows the user to change the internal nodal values of the weight function (default $q=1.0$) used in the domain integration.

MoDified CRaCK CLoSure

Strain energy release rates and corresponding stress intensity factors are calculated through the Modified Crack Closure Integral method and displayed in an *auxiliary window*. If more than one crack tip is involved in the problem, one of them should be selected first.

MORE OPTIONS

This button makes the other postprocessor features available again.

RETURN

Returns the process to the MAIN PAGE.

CASCA Menu Reference

This section of the manual describes the menu options available in the CASCA program. CASCA is a program that can be used to generate initial meshes for FRANC2D.

MAIN Page

Set Scale

This button activates the SET SCALE page, whose functions are described in the Set Scale Page section below.

Geometry

This button activates the GEOMETRY page, whose functions are described in the Geometry Page section below.

SubRegions

This button activates the SUBREGIONS page, whose functions are described in the SubRegions Page section below.

Subdivide

This button activates the SUBDIVIDE page, whose functions are described in the Subdivide Page section below.

Mesh

This button activates the MESH page, whose functions are described in the Mesh Page section below.

Mesh Boundary

This button displays the current mesh boundary only. The full mesh can be displayed by entering the Mesh page.

Write Mesh

Writes the current mesh information in the FRANC2D .inp file format. This file can be read into FRANC2D directly. The file name (without the .inp extension) is given in the *program control window* via the keyboard.

Read

Reads a CASCA restart file. The file name (without the .csc extension) is given in the *program control window* via the keyboard.

Write

Writes a CASCA restart file. The file name (without the .csc extension) is given in the *program control window* via the keyboard.

Grid

Toggles the construction grid on and off.

Big Window

This button allows the user to enlarge all windows controlled by CASCA to approximately one-third larger than their default size.

(NOTE: This function is inoperative with the X-Window version of CASCA)

RESET, MAGNIFY, ZOOM, PAN, SNAP

This buttons function as they do in the FRANC2D program. See the description in the FRANC2D menu reference section.

END

Exits the program. *A restart file is not written automatically.*

Set Scale Page

The Set Scale page allows you modify the data window scale and grid sizes used when defining a problem. By default, the data window is 12 units wide by 12 units high,

with grid squares that are one unit in size. The origin of the data space is the middle of the window.

Data Size

The “Data Size” is the data window width and height in world coordinates. The default data size is 12 units. The current number of grid squares remains the same when the data size is changed, however, the spacing (described below) does change.

Grid Center

The “Grid Center” is the position of the center of the data window. This allows a more permanent mesh translation during model generation. This location will stay in the center of the window if the RESET option is selected. The default center position is (0,0).

Spacing XY

This option changes the widths and heights of the grid spacing while maintaining the current data size. The default spacing is 1 unit.

Spacing X

This option changes the widths of the grid spacing while maintaining the current heights.

Spacing Y

This option changes the heights of the grid spacing while maintaining the current widths.

Geometry Page

Element generation can take place only after the problem geometry has been specified. Use the geometry command to create closed geometric regions that can be meshed. Regions with differing material types must each be their own closed geometrical region.

Lines Connected

This option allows you to draw multiple line segments. Each segment begins where the previous segment ends. The coordinates of the segment end points can be entered exactly with the **KEYPAD** option. Each of the segments can act as a portion of a boundary for a geometrical region. Select **QUIT** to exit this mode.

Get Line

This option allows you to create one line segment. Point and click at two locations to specify the line segment. The coordinates of the segment end points can be entered exactly with the **KEYPAD** option. Select **DONE** to accept the line, select **QUIT** to exit without saving the line.

Get Circle

This option allows you to create a circle. You can create an **ARC** of a circle, or a **WHOLE** circle. The word in capital letters on menu option tells which mode is currently active. For an **ARC**, specify the beginning, ending, and center points of the arc. The points are specified in clockwise order. For a **WHOLE** circle, specify one point on the circle, and the center of the circle. The coordinates of these points can be entered exactly with the **KEYPAD** option. Select **DONE** to accept the line, select **QUIT** to exitout with saving the line.

Delete

This option allows you to delete items. Select the item and then select **DONE**. Repeat for more items.

Attributes

This option activates the **ATTRIBUTES** page, which allows you to define analysis and material types. Usually this will take place before meshing. However, these things can be set at any time.

Analysis Type

Allows you to set the analysis type to Plane Stress (default), Plane Strain, or Axisymmetry.

Materials

This option activates the CASCA materials page. Most of the options in this page are similar to those in FRANC2D. Refer to the FRANC2D Menu Reference for descriptions of these. Two exceptions are **Attach**, which allows you to attach the current material type to a region, and **Check**, which sets the current material type to the selected region.

Specify Hole

Holes must be specified so that the program will not expect a mesh for a region, and will not automatically fill a hole with elements. Select this option and point and click on a geometrical region.

Unspecify Hole

Changes a hole back to a normal meshable region.

Grid

Toggles the construction grid on and off.

SubRegion Page

The option on this page allow you to decompose geometric regions into smaller sub-regions. All sub-regions that have the same parent region share the same material type. Sub-regions can be used in many cases to simplify meshing. They are especially useful for creating transition areas where element sizes change significantly from one side of the region to the other. The options on the SubRegion Page are similar to those described above for the Geometry Page.

Subdivide Page

The options on this page allow you to specify the nodal densities along the boundaries of regions and sub-regions. This is a necessary step before a region can be meshed.

No. of Segments

Allows you to set the current number of element edge segments to be attached to the boundaries. The default number is 4.

Ratio

Allows you to set the ratio of the shortest element edge along a boundary to the longest. The arrows on the edges indicate the direction of the edge. The ratio is entered as two integers. The default ratio is 1 to 1.

Quadratic/Linear

Allows you to specify if quadratic or linear elements are to be generated. *For FRANC2D analysis, always use Quadratic, the default.*

Subdivide

Puts the program in a mode where you may specify one or more edges to be subdivided. Edges are specified by pointing to them and clicking. To change the subdivision of an edge, simply resubdivide it with a different number of segments and/or a different ratio.

All Remaining

Subdivides all the, as of yet, unsubdivided edges using the currently specified ratio and number of segments.

Reset All

Erases all the subdivisions for all edges.

Mesh Page

The options on this page allow you to mesh all the regions in the model.

Q8 Q4, T6 T3

These two buttons allow you to select the element types to be used for mesh generation. *For FRANC2D analysis, always use Q8 and/or T6 elements, never Q4 or*

T3. These options are available so that CASCA can be used as a mesh generator for programs other than FRANC2D.

Right Left, UnionJack Optimum

These two buttons allow you to select the element configurations for triangle element generation. These options are primarily of academic interest only.

W/O CORNER PTS, PROMPT CORNERS

This button allows you to set the corner specification mode for the bilinear meshing algorithms. In **W/O CORNER PTS** mode, the program tries to determine the corners of the region to be meshed automatically. In the **PROMPT CORNERS** mode, the programs asks the user to select the corners.

Bilinear 4side

Generates elements in a four sided region using a transfinite mapping algorithm. Opposing sides of the region must have the same number of subdivisions.

Bilinear 3side

Generates elements in a three sided region using a transfinite mapping algorithm. This is essentially a “collapsed” version of the four sided algorithm. Two of the sides of the region must have the same number of subdivisions.

Transition

Generates elements in an arbitrarily shaped region. If the **NO INTERIOR PT** option is selected, only the nodes defined on the region boundary are for element generation. The **GENERATE INT PT** option tells the program to create interior nodal points that are consistent with the segment sizes along each edge.

Construction

Allows you to build elements manually, one edge at a time. This is not operational in all versions of the program.

Automatic

Automatically generates elements for all regions not already meshed. The program tries to determine the algorithm most appropriate for each region.

Delete

Unmeshes a region.

Subdivision Points

Toggles the subdivision point indicators on and off.

Appendix A – The .inp file format

The format of the FRANC2D *.inp files are described in this appendix. These files are formatted files that describe an initial mesh configuration. The format of the files is relatively simple, which makes writing translators from various meshing programs a straightforward process.

Title Line:

The first line of the file is a program title. Titles can be up to 40 characters long.

Control Line:

The second line contains four control items. This line can be specified in free format (spaces are not significant except to separate values).

num_nodes	the number of nodes in the model
num_elems	the number of elements in the model
num_materials	the number of materials in the model
prob_type	the problem type (0-axisymmetry, 1-plane stress, 2-plane strain)

Material Lines:

The material lines give the material properties; there is one line for each of the material types. Material numbers should be ordered sequentially from 1, and should appear in order in the file. Only elastic isotropic and elastic orthotropic material types can be specified in a .inp file. Other material types must be specified from within the program. The FORTRAN format used for reading these lines is '(I5,14F10.2)'.

*Note: properties for nonlinear materials currently cannot be specified in a *.inp. They must be set interactively while running the program.*

The first item on the line is the material type. This should be 1 for isotropic materials, and 2 for orthotropic. The information on the remainder of the line depends on the material type.

Isotropic:

mat_type	1 for isotropic materials
E	elastic modulus
Nu	Poisson's ratio
thickness	ignored for plane strain and axisymmetry
KIc	fracture toughness (only used with the INTERACTION option)
density	used for body force loadings

Orthotropic:

mat_type	2 for orthotropic materials
E1	elastic modulus in first (x') material direction
E2	elastic modulus in the second (y') material direction
E3	elastic modulus in the third (out of plane) material direction
G12	in plane shear modulus
Nu12	Poisson's ratio in plane
Nu13	Poisson's ratio in the 1-3 (x'-z) plane
Nu23	Poisson's ratio in the 2-3 (y'-z) plane
Beta	angle between the x-y coordinates and the material (x'-y') coordinates
thickness	ignored for plane strain and axisymmetry
KIc1	fracture toughness in the first (x') material direction
KIc2	fracture toughness in the second (y') material direction
density	used for body force loadings

Element Lines:

The element lines define the node incidences for each of the elements. There should be one of these lines for each of the elements in the problem. These lines specify the element number, the material number, and either 6 or 8 node numbers (corresponding to 6- and 8-noded elements). The FORTRAN format used for reading these lines is '(10I5)'.

elem_num	the element number
mat_num	the material number
nodes(8)	node numbers

Node Lines:

The node lines define the coordinates for each node. There should be one of these lines for each of the elements in the problem. These lines specify the node number along with the coordinates. Nodes should be numbered consecutively from 1. These lines can be specified in free format

node_num	the node number
X_coord	the x coordinate of the node
Y_coord	the y coordinate of the node

Example

Below is an example *.inp file for the mesh shown at the right. There are two 8-noded elements and four 6-noded elements. The dimensions of the problem are four units by four units centered about (0,0).

example FRANC2D .inp file

```
23 6 1 1
1 2.90E+04 2.50E-01 1.00E+00 1.00E+00 1.00E+00
1 1 23 1 13 2 16 17 0 0
2 1 16 2 13 12 18 3 0 0
3 1 16 3 18 8 22 15 0 0
4 1 10 4 13 14 19 7 20 9
5 1 10 11 21 5 18 12 13 4
6 1 23 6 19 14 13 1 0 0
1 -1.000000E+00 1.000000E+00
2 0.000000E+00 1.000000E+00
3 1.000000E+00 1.000000E+00
4 0.000000E+00 -1.000000E+00
5 2.000000E+00 -1.000000E+00
6 -2.000000E+00 1.000000E+00
7 -2.000000E+00 -1.000000E+00
8 2.000000E+00 1.000000E+00
9 -1.000000E+00 -2.000000E+00
10 0.000000E+00 -2.000000E+00
11 1.000000E+00 -2.000000E+00
12 1.000000E+00 0.000000E+00
13 0.000000E+00 0.000000E+00
14 -1.000000E+00 0.000000E+00
15 1.000000E+00 2.000000E+00
16 0.000000E+00 2.000000E+00
17 -1.000000E+00 2.000000E+00
18 2.000000E+00 0.000000E+00
19 -2.000000E+00 0.000000E+00
20 -2.000000E+00 -2.000000E+00
21 2.000000E+00 -2.000000E+00
22 2.000000E+00 2.000000E+00
23 -2.000000E+00 2.000000E+00
```

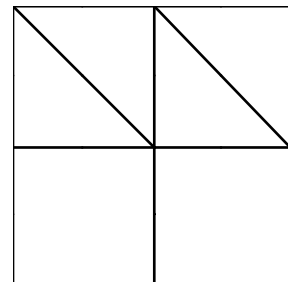

Appendix B – The .tdi file format

The format of thermal distribution files are described in this appendix. These files allow temperature distributions to be used in a FRANC2D analysis. Possible sources for such distributions may be measured values, thermal analyses, or conjecture.

The .tdi files describe the temperatures at a number of point on the boundary of a domain along with temperatures at some of the point in the interior. The program automatically generates a triangular mesh and interpolates temperature values over this mesh.

The thermal distribution information is used at analysis time to generate a mechanical load case due to initial thermal strains. Because the temperature distribution uses its own mesh, which is not tied to the mesh used for stress analysis, the distribution need only be specified once. Mesh refinement and crack propagation can be performed while the original temperature distribution is retained.

The File Format

tdi files contain the coordinates and temperatures for two different types of points: points on the boundary, and points in the interior. The boundary points must be ordered so that they describe the boundary of the analysis region in *counter-clockwise* order. Internal points can be specified in any order.

The file is read in “free format”, which means that spaces are not significant other than to separate values. The first line in the file contains control information. The remaining lines describe temperature points. Each of these contains four pieces of information: 1) a flag that identifies this as a boundary or an interior point, 2) the X coordinate of the point, 3) the Y coordinate of the point, and 4) the temperature.

Coefficient (first) Line:

FLG CTE

FLG One character flag. Should be ‘C’ or ‘c’

CTE The value of the coefficient of thermal expansion for the program

Example:

C 0.17E-7

Temperature (remaining) Lines:

FLG XCoord YCoord Temp

FLG One character flag. Should be ‘B’ or ‘b’ for a boundary node. Should be ‘I’ or ‘i’ for an interior node.

XCoord The X coordinate of the point.

YCoord The Y coordinate of the point.
Temp The temperature of the point.

Examples:

B 0.4 5.0 100.0

I 8.0 4.3 125.5

Index

ACCEPT 34
ADD APPL FAC 40
ADD BIMAT GAP 38
ADD ELEM 45
ADD GAP ELEM 38
ADD INTERFC 37
ADD NL INTRFC 37
ADD NODES 34
ADD Q8 32
ADD SUBJ FAC 40
ADD T6 32
ADJ LOAD FAC 44
All Remaining 50
ANALYSIS 21
Analysis Type 49
ANNOTATE 22
APPLD DISP 28
Attach 49
Attributes 49
AUTOMATIC 34, 52
auxiliary window 1

BIG WINDOW 22, 47
Bilinear 3side 51
Bilinear 4side 51
BODY LOAD 26
BOUNDARY 21, 41

CASE 25, 39, 42, 44
Check 49
checkpoint files 4
CIRCLE-PLOT 40
CLEAR LIMITS 41
COHESIVE CRACK 34
COHESV METH 34
COLOR SCALE 41

COMP 41
COMP DIST 27
COMP RS DIST 27
CONSTANT 26, 28
Construction 52
CONTOUR 41
CQ8 TO T6 38
CRACK DEF 31
csc files 3
cursor 1

DATA FILE 28
Data Size 47
DEF DOMAIN 45
DEF-BOUND 42
DEF-DASHED 42
DEFAULTS 42
DEFRND MESH 42
DELETE 27, 49, 52
DELETE CASE 25
DIRECT STIFF 21
DISP DIST 27
DISP RS DIST 27
DIST LOAD 26
DIST MESH 27
DRAG NODE 32
DSP CORR SIF 44
DYN RELAX 21

EDG CRACK PRESS 28
EDGE CRACK 34
EDGE DISP 28
EFF STRESS 41
ELAST ISOTROPIC 29
ELAST ORTHOTROPIC 29
ELEM DIST 27

ELEM STIFF 21
ELEMENTS 26
END 23
EPLAST ISO 29
EQN NUM 21
EVAL JINT 45
EXTERN DIST 27

FATIGUE PLTS 45
FIX EDGE X 24
FIX EDGE XY 24
FIX EDGE Y 24
FIX IND X 24
FIX IND XY 24
FIX IND Y 24
FIXITY 24
FRACT MECH 39

G-MAX 44
GAP ELEM 29, 34
GENERATE INT PT 52
Geometry 46
Geometry Page 48
Get Circle 49
Get Line 48
gra files 5
GRF files 4
Grid 47, 50
Grid Center 48

hardcopy 5, 23
HELP 23

IN-SITU LOAD 26
inp files 3
INT CRACK 34
INT CRACK PRESS 28
INTEGRATE 39, 40
INTER FORCE 41
INTERACTION 44
INTERFC OFF/ON 37
INTFC METH 34
INTFC TOUGH 31
INTRFCE FIX 25
INTRFCE LOAD 27

J INTEGRAL 45

KEY IN DATA 28
KEY LOAD FAC 44
KILL ELEM 32, 34

LAGRANGIAN 28
LINE-PLOT 39
LINEAR 21, 26, 28
Lines Connected 48
LOAD CASE 27
LOAD STEPS 21
LOADS 25

MAGNIFY 23
MAT 29
MAT NONLIN 21
MATERIAL 26, 28
MATERIAL DIST 27
Materials 49
MD CRCK CLOS 45
Mesh 46
Mesh Boundary 46
Mesh Page 51
message window 1
MODIFY 21
MOVE CRACK 34
MULT NODE-INFORM 43

NEW CIRCLE 40
NEW CRACK 34
NEW LINE 39, 40
NEW MAT 29
NL INTERFACE 29
NO INTERIOR PT 51
No. of Segments 50
NOD INT FORC 40
NODE INFO 22
NODE-INFORM 42
NON-COHESIVE 34
NORMAL 26, 39

operations window 1
ORG-FULL 42
ORG-OFF 42
ORG-SOLID 42

PAN 23
POINT LOADS 25
POST-PROCESS 22

postscript 5
PRE-PROCESS 21
PROBLEM TYPE 31
program control window 1
PROMPT CORNERS 51
PT DISP 28

Q8 Q4 51
QUADRATIC 26, 28
Quadratic/Linear 50
qVALUES 45

RADIAL-PLOT 40
Ratio 50
Read 47
READ FILE 22
REFINE INTERF 34
REM ALL 45
REM ELEM 45
RES STR FILE 43
RESET 23
Reset All 51
RESIDL LOAD 27
restart files 4
Right Left 51
rsp files 4

S-MIN 44
sdb files 4
SET LIMITS 41
Set Scale 46
Set Scale Page 47
SHEAR 26, 39
SHOW ANGLE 36
SIF HISTORY 45
SIG 1 41
SIG 2 41
SIG-THETA 44
SIGRR 40
SIGRT 40
SIGTT 40
SIGXX 39, 40, 41
SIGXY 39, 40, 41
SIGYY 39, 40, 41
SINGULARITY 31
SNAP 23
SOLVER 21
SOLVER PARAM 21

Spacing X 48
Spacing XY 48
Spacing Y 48
Specify Hole 49
STAND METH 34
STR EN DNS 41
STRESS-BAR 41
STRUCT MESH 27
SUBDIVIDE 37, 46, 50
Subdivide Page 50
Subdivis Pts 52
Subregion Page 50
SubRegions 46
SWITCH ALL 29
SWITCH ELEM 29

T6 T3 51
T6 TO CQ8 38
TAU MAX 41
tdc files 4
tdi files 3
TENS 41
THERMAL LOAD 26
TOLERANCE 21
TOTAL/resid 39, 40, 41
Transition 51

UDISP 40
UnJck Optim 51
Unspecify Hole 49
USER DEFINED 31

VALUE 42
VDISP 40

W/O CORNER PTS 51
wdb files 4
WHOLE MESH 26
Write 47
WRITE FILE 22
Write Mesh 46

X BOTH Y 28
X GLOBAL 26

Y GLOBAL 26

ZOOM 23